



2026

# RANGE READY.™





# FOUNDATION FOR MAXIMUM ACCURACY.

FOUNDATION FOR MAXIMUM ACCURACY	2-3
RANGE READY™	4-5
NEW PRODUCTS	6-7
RATCHET REST	8-11
HIGH-PERFORMANCE TOOLS FOR GUNS	12-35
HIGH PERFORMANCE GUN CLEANING™	36-51
GUN-SPECIFIC MULTI-TOOLS	52-57
UNWAVERING COMMITMENT	58-59

Real Avid's commitment to innovation makes us the leader in gun tools and cleaning. This year, we're going further, redefining what range gear can be with the launch of Range Ready™.

At the center of this new category are the Ratchet Rest™ – Adjustable Height Shooting Bags, delivering instant adjustability, rock-solid stability and unmatched shooting confidence. It's the smarter, faster way to lock in accuracy and elevate every range session.

From Master Grade® Tools and High Performance Gun Cleaning™ products to industry-leading Gun Multi-Tools and now Range Ready, every Real Avid product is built for real-world performance. Trusted by pros and everyday shooters alike, our gear empowers you to prepare smarter, perform better and shoot with confidence.





# RANGE



# READY.™

Real Avid Range Ready is the new standard for shooters who demand more from their time on the range. It's not just gear, it's a mindset. A philosophy that elevates shooting fundamentals. A commitment to show up focused, prepared and fully equipped to push limits and sharpen skills. With innovations like the Ratchet Rest™ – Adjustable Height Shooting Bags and a growing ecosystem of purpose-driven range products, Range Ready empowers you to own every shot, every session. This is for the shooter who doesn't just go to the range, but arrives with intent. With confidence. With an edge. Be ready. Be precise. Be Range Ready.



**NEW 2026**

# NEXT-LEVEL THINKING.

## INTRODUCING NEW PRODUCTS

Innovation has always been the driving force behind Real Avid, and our 2026 lineup pushes that vision further than ever. Each new release is purpose-built to solve real problems shooters face, blending advanced engineering with practical, shooter-focused design. From the bench to the field to the range, our products reflect a relentless pursuit of smarter solutions, gear that doesn't just raise expectations but redefines them.

RATCHET REST™ – ADJUSTABLE  
HEIGHT SHOOTING BAGS  
PAGE 8 - 11



Front Rest (Large)

AVAILABLE IN  
THREE SIZES

Rear Rest (Small)

Front/Rear Rest (Medium)

GUM-MAX GREASE  
PAGE 40 - 41



PRIME 223 CLEANING KIT  
PAGE 48





# MICRO-ADJUSTABLE PRECISION.

GET ON TARGET QUICKLY WITH REPEATABLE ACCURACY.



## **RATCHET REST™** **ADJUSTABLE HEIGHT SHOOTING BAGS**

The world's first precision height-adjustable shooting bags with integrated Accu-Click™ technology. These innovative rifle rests combine the stability of traditional shooting bags with built-in adjustment mechanisms, allowing shooters to quickly achieve and maintain exact positioning. The result is a consistent, repeatable shooting platform that enhances accuracy across all distances.

### **DOUG KOENIG AND REAL AVID: A PARTNERSHIP IN PRECISION AND PERFORMANCE**

*In the world of competitive shooting, few names command as much respect as Doug Koenig. With an unparalleled track record of championships and an unwavering dedication to precision, Doug embodies the very essence of shooting excellence. His career is a testament to the relentless pursuit of perfection, something that aligns seamlessly with Real Avid's mission of equipping shooters with the most advanced tools and gear to enhance their performance.*

*Now, that shared commitment to precision and readiness takes center stage as Doug Koenig partners with Real Avid, ushering in a new era of firearm maintenance, range preparation and shooting excellence.*

# GET ON TARGET WITH MICRO ADJUSTMENTS.



Fine-tooth internal mechanism for rapid, click-by-click elevation control. One-handed operation keeps you in position and on target. Every click is stable, repeatable and locked. Get on target faster and stay on target at any distance.

**ACCU-CLICK™**  
**TECHNOLOGY**

MICRO-ADJUST HEIGHT  
CONTROL KEEPS YOU ON TARGET  
WITH REPEATABLE ACCURACY.

WHETHER YOU'RE ZEROING A RIFLE,  
CALLING SHOTS AT DISTANCE OR  
DIALING IN FOR COMPETITION THE  
RATCHET REST™ – ADJUSTABLE HEIGHT  
SHOOTING BAGS GIVE YOU CONTROL  
OF EVERY SHOT.

# DELIVERS CONSISTENT, RELIABLE SHOOTING PERFORMANCE.

YOUR SHOOTING POSITION  
SHOULDN'T CONFORM  
TO YOUR BAGS.  
**OUR BAGS ADJUST TO YOU.**



## ENGINEERED TO MAINTAIN STABILITY AND PERFORMANCE SHOT AFTER SHOT.

Built for years of hard use. A waxed canvas top grips the rifle, a rubberized base locks to any surface and heat-resistant stitching withstands muzzle blast. Inside, poly bead fill holds shape shot after shot. Reinforced straps and MOLLE keep it ready for the field.

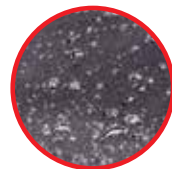

**WAXED CANVAS TOP**  
Water and wear-resistant rifle grip



**RUBBERIZED BASE**  
Non-slip hold on any surface



**HEAT-RESISTANT STITCHING**  
Withstands 400°F muzzle blast



**POLY BEAD FILL**  
Moisture-proof, won't attract rodents, harden, settle or mildew



**FOAM DISC CORE**  
Flat, stable shooting surface (front rest - large only)



**REINFORCED CARRY STRAP & MOLLE**  
Built for transport and gear integration

# CLICK INTO A NEW LEVEL OF ACCURACY.

## AVAILABLE IN THREE SIZES

FRONT REST (LARGE),  
FRONT/REAR REST (MEDIUM),  
REAR REST (SMALL)

**ACCU-CLICK™**  
TECHNOLOGY

MICRO-ADJUST HEIGHT  
CONTROL KEEPS YOU ON TARGET  
WITH REPEATABLE ACCURACY.



## RATCHET REST™ - ADJUSTABLE HEIGHT SHOOTING BAGS

Real Avid's Ratchet Rest – Adjustable Height Shooting Bags combine the stability of a shooting rest with the precision of a ratcheting elevation system. Built for shooters who demand repeatable accuracy, these modular bags feature a click-adjustable core that lets you fine-tune your shooting position without shifting or stacking. Filled with durable, mildew-resistant poly beads and stabilized by a 2" foam base (front rest-large only), they deliver rock-solid performance without the mess of sand or corn. Rugged waxed canvas, heat-resistant stitching and a grippy rubberized base make them tough enough for bench or field use. Available in Front Rest (Large), Front/Rear Rest (Medium) and Rear Rest (Small).

- NEW RATCHET REST** — ADJUSTABLE HEIGHT SHOOTING BAG - FRONT LARGE
- NEW RATCHET REST** — ADJUSTABLE HEIGHT SHOOTING BAG - FRONT/REAR MEDIUM
- NEW RATCHET REST** — ADJUSTABLE HEIGHT SHOOTING BAG - REAR SMALL

- ITEM # AVRSBL
- ITEM # AVRSBM
- ITEM # AVRSBS

# THE FIRST PLUG & PLAY HANDS-FREE ACCESSORY SYSTEM FOR GUN DIY® KEEPS GETTING BETTER.

SMART-ASSIST QUICKLY CONNECTS WHENEVER AND WHEREVER YOU NEED THEM.



**SMART ASSIST**

## SMART-ASSIST™ QUICK-CONNECT SYSTEM – ESSENTIAL 3-PACK WITH SMART-DOCK™

The smart and easy way to mount accessories to your work area. Simply attach the Smart-Assist Accessory System to your Master Gun Vise®, Master Gun Workstation®, Bore-Max® Master Cleaning Kit and Mobile Workstation or benchtop for a better working experience. The Quick-Connect locking system offers a one-handed, flexible way to magnify or illuminate your Gun DIY™ projects while watching your favorite gunsmith.

ITEM # AVMVACC

180 LUMEN WORK LIGHT  
3 SELECTABLE SETTINGS TO ILLUMINATE DARK, HARD-TO-SEE AREAS.



5-INCH MAGNIFYING GLASS  
GREAT FOR MAGNIFYING DELICATE TASKS.

QUICK-CONNECT SMART-DOCK SYSTEM



CELL PHONE HOLDER  
A HANDS-FREE WAY TO WATCH OR CREATE HOW-TO VIDEOS.

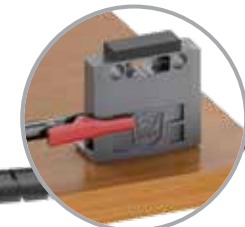

ATTACHES TO YOUR WORKBENCH

UPGRADE YOUR WORKBENCH EXPERIENCE.

# SMART ASSIST

## ACCESSORY SYSTEM

WORKS ON THE REAL AVID MASTER GUN VISE®, MASTER GUN WORKSTATION®, MOBILE WORKSTATION OR MOUNTS TO YOUR BENCH.



ATTACHES TO MASTER GUN VISE



ATTACHES TO MASTER GUN WORKSTATION



ATTACHES TO MOBILE WORKSTATION

FOUR CORNER SMART-DOCKS

# DOCKING SYSTEMS QUICKLY CONNECT SMART-ASSIST ACCESSORIES WHENEVER AND WHEREVER YOU NEED THEM.

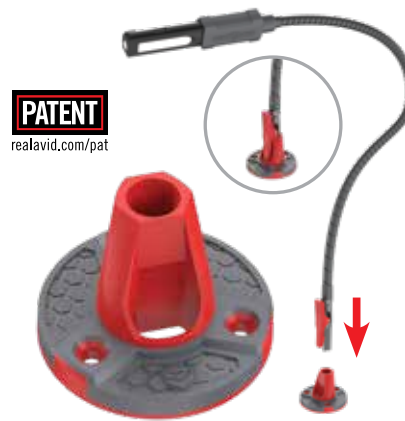

**PATENT**  
realavid.com/pat

## SMART-ASSIST SURFACE MOUNT

3-PACK SURFACE AND FLUSH MOUNT.

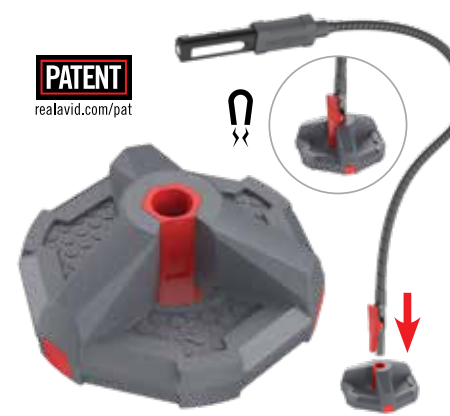

**PATENT**  
realavid.com/pat

## SMART-ASSIST MAGNETIC MOUNT

HANDS-FREE MAGNETIC MOUNTABLE SMART-ASSIST DOCK.



**PATENT**  
realavid.com/pat

## SMART-ASSIST C-MOUNT

UP TO 2-1/4" MOUNTING CAPACITY FOR A SECURE FIT.

## SMART-ASSIST™ DOCKING MOUNTS

Smart-Assist Docking Mounts redefine hands-free efficiency. The Surface Mount - 3-Pack optimizes space with a reversible design, attaching to multiple surfaces for instant assistance. The Magnetic Mount, with six strong magnets, offers hands-free enhancement on steel surfaces. The C-Mount guarantees a stable fit on flat edges, with reversible mounting and four Smart-Docks™ for customized assistance. Upgrade your workspace with Smart-Assist for seamless, intelligent work assistance and enhanced productivity.

SMART-ASSIST — SURFACE MOUNT 3-PACK  
SMART-ASSIST — MAGNETIC MOUNT  
SMART-ASSIST — C-MOUNT

ITEM # AVSASDM  
ITEM # AVSAMM  
ITEM # AVSACM

COMPATIBLE WITH

## SMART ASSIST ACCESSORIES



180 LUMEN WORK LIGHT

5-INCH MAGNIFYING GLASS

CELL PHONE HOLDER

(ACCESSORIES NOT INCLUDED - SOLD SEPARATELY)

# THE FIRST EVER TRUE GUN VISE.

**PATENT**  
realavid.com/pat



COMPATIBLE WITH

**SMART  
ASSIST**  
ACCESSORIES



180 LUMEN  
WORK LIGHT

5-INCH MAGNIFYING  
GLASS

CELL PHONE  
HOLDER

(180 LUMEN WORK LIGHT, 5-INCH MAGNIFYING GLASS AND  
CELL PHONE HOLDER NOT INCLUDED - SOLD SEPARATELY)

## MULTI-AXIS BENCH-MOUNT VISE WITH TORQ-LOK™



Angle the lower receiver for fast and easy installation of bolt release pin.



Optimally position lower receiver to install buffer and buffer detent pin.



Ideal positioning for inverted maintenance and installations.



Position the barrel and upper receiver downward into the trash for bore and barrel cleaning.



Position the lower receiver to install pivot pin, spring & detent. (Smart-Fit® AR15 Vise Block sold separately)



Optimal lock-down positioning for high-torque applications. (Lug-Lok Upper Vise Block™ sold separately)

## MASTER GUN VISE®

The first real bench vise made exclusively for guns and gun tools. Whether you're building and customizing, repairing and cleaning or mounting scopes and accessories, this vise improves every part of the GUN DIY® experience. Quickly reposition your gun to any orientation without ever removing it from the vise. Insert the Torq-Lok pin for applying heavy force. Use the removable and reversible Smart-Jaws™ – Gun-Fit™ for a specific gun grip or turn the leveling knob for simple scope mounting and leveling. Build. Customize. Repair. Mount. Clean... All hail the king.

ITEM # AVARAMV

# THE ULTIMATE FOUNDATION FOR GUN DIY®

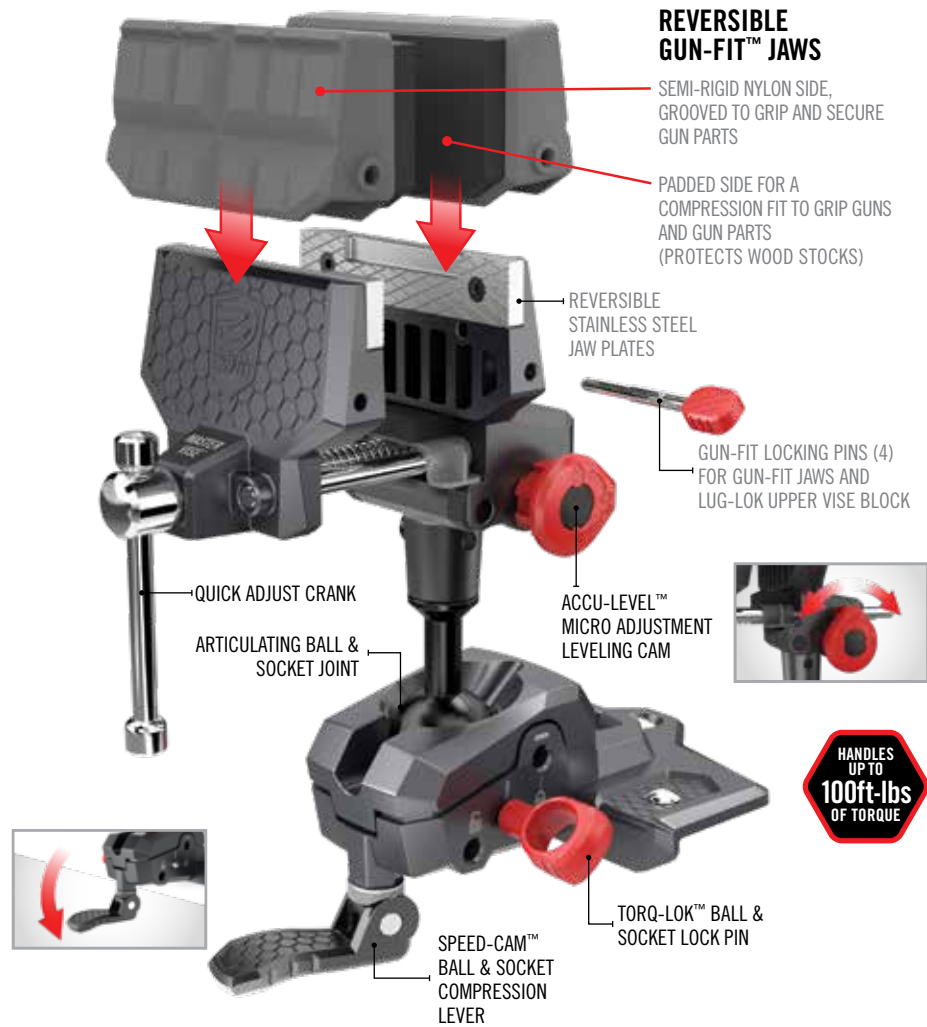

## REAL AVID® TOOLS THAT THE MASTER GUN VISE IS DESIGNED TO PAIR WITH



Vise jaws integrate seamlessly with the Smart-Fit® AR15 Vise Block. (Smart-Fit sold separately)



Securely anchor Lug-Lok Upper Vise Block™ with Gun-Fit locking pins. (Lug-Lok sold separately)

## PERFECT FOR THE AR15 – GREAT FOR ANY GUN



The versatile and modular Gun-Fit Jaws allow nearly any gun or gun part to be safely and securely clamped in the vise for unlimited Gun DIY® tasks.

# UPGRADE VISE JAWS FOR SPECIFIC JOBS.

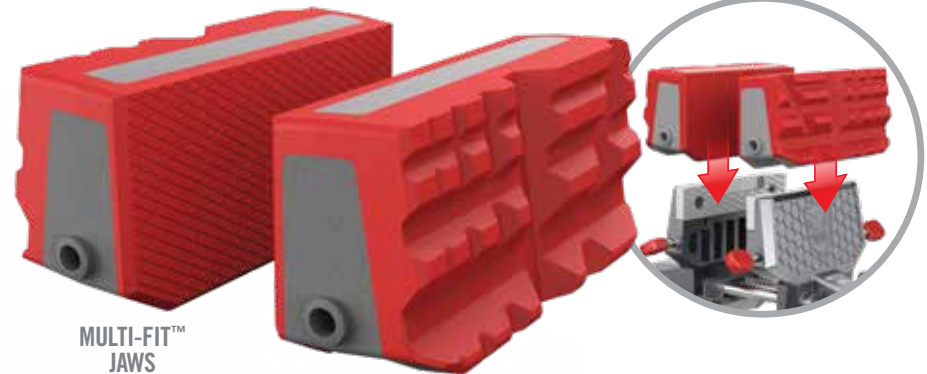

**PATENT**  
realavid.com/pat

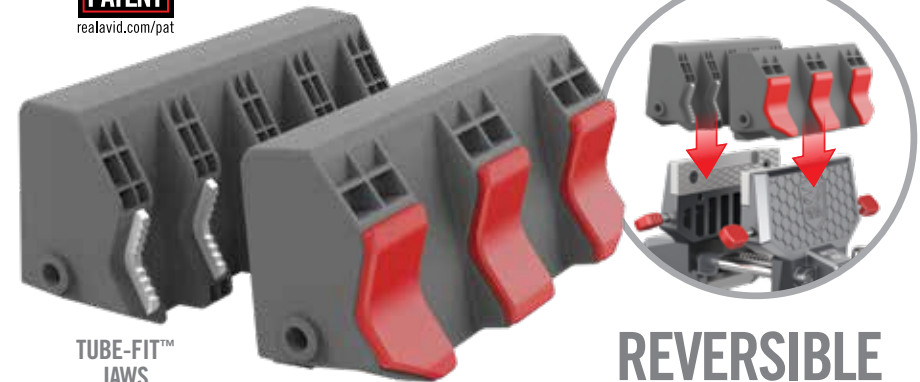

**PATENT**  
realavid.com/pat

## REVERSIBLE JAWS.

## SMART-JAWS™ FOR MASTER GUN VISE®

Different jobs require a different gripping surface for your vise. Upgrade your Master Gun Vise with the new Smart-Jaws – Multi-Fit for most long guns, pistols, barrels and guide rods. These non-marring thermoplastic rubber jaws work on all sizes and shapes of guns and parts. For cylindrical objects like suppressors, PVC, cast-iron pipe and all types of tubing, upgrade to the new Smart-Jaws – Tube-Fit. The non-marring thermoplastic rubber side is great for suppressors and barrels. Use the hard-gripping metal side for tough jobs like cast-iron pipe for the ultimate grip.

SMART-JAWS — MULTI-FIT  
SMART-JAWS — TUBE-FIT

ITEM # AVSFJMF  
ITEM # AVSFJPF

# THE MOST CAPABLE SET OF MASTER GRADE® AR15 TOOLS EVER ASSEMBLED.



**PATENT**  
realavid.com/pat

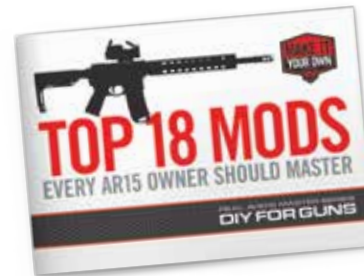

**INCLUDED FREE**  
STEP-BY-STEP, DETAILED  
INSTRUCTIONS FOR THE  
TOP 18 AR15 MODIFICATIONS

- ACCU-PUNCH® HAMMER
- MASTER-FIT® WRENCH SET
- MASTER-FIT TORQUE WRENCH
- LUG-LOK UPPER VISE BLOCK™
- SMART-FIT® AR15 VISE BLOCK
- MASTER BENCH BLOCK® - AR15
- EASY-GRIP™ HANDGUARD TOOL
- AR15 PIVOT PIN TOOL
- AR15 PIN PUNCH SET
- PIN ALIGNMENT TOOL
- PROFESSIONAL TOOL CASE

**COMPREHENSIVE MASTER GRADE AR15 TOOL SET PLUS  
DETAILED INSTRUCTIONS FOR POPULAR GUN DIY® PROJECTS.**

## **ARMORER'S MASTER KIT® - AR15 PRO**

This upgraded kit is the most capable set of Master Grade AR15 tools ever assembled to build, repair or customize your gun, housed in a convenient, professional case. Featuring an extensive set of task-specific crowfoot wrenches for the most common AR15 assembly nuts and a heavy-duty armorer's torque wrench. Kit includes both upper and lower vise blocks to confidently secure your gun parts for superior control. A comprehensive set of AR15 pin punches and armorer's hammer pair with the 11-function bench block. To get you started, a step-by-step instructional book is included to guide you through the top 18 modifications made to AR15s. Upgrade to Master Grade®!

ITEM # AVAMKPRO

# THE #1 SELLING ARMORER'S KIT.

- ARMORER'S MASTER WRENCH® WITH REPLACEMENT HAMMER HEADS
- LUG-LOK UPPER VISE BLOCK™
- SMART-FIT® AR15 VISE BLOCK
- MASTER BENCH BLOCK® - AR15
- TORQUE WRENCH
- EASY-GRIP™ HANDGUARD TOOL
- AR15 PIVOT PIN TOOL
- AR15 PIVOT LOCK
- AR15 PIN PUNCH SET
- PIN ALIGNMENT TOOL
- ACCU-GRIP™ PICKS
- BORE ILLUMINATOR/SAFETY FLAG
- FRONT SIGHT ADJUSTER TOOL
- PROFESSIONAL TOOL CASE



**PATENT**  
realavid.com/pat



**INCLUDED FREE**  
STEP-BY-STEP, DETAILED  
INSTRUCTIONS FOR THE  
TOP 18 AR15 MODIFICATIONS

ADVANCED MASTER GRADE® TOOLS PLUS DETAILED GUN DIY® INSTRUCTIONS TO CUSTOMIZE YOUR AR15.

## ARMORER'S MASTER KIT® - AR15

This kit of Master Grade Tools and how-to information equips you to confidently tackle everything from building your own gun from the ground up to customizing or modifying an existing gun. With better tolerances, materials and expanded capability, every tool is carefully designed to make each job as simple and easy to execute as possible. Housed in a professional tool case and equipped with step-by-step instructions, you will be able to work smarter and create better guns regardless of your experience level.

ITEM # AVAR15AMK

# “HOW-TO” FOR GUNS MADE SIMPLE.

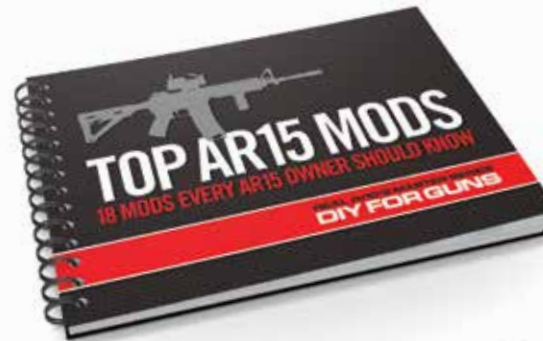

STEP-BY-STEP,  
DETAILED INSTRUCTIONS  
FOR THE TOP 18 AR15  
MODIFICATIONS



18 MODS EVERY AR15  
OWNER SHOULD KNOW



## TOP AR15 MODS

To serve the huge base of AR15 owners who are fueling the growth of aftermarket accessories, we created a master Gun DIY® instruction manual. It's packed with easy-to-follow, photo illustrated, step-by-step, how-to-do-it directions for the 18 most popular modifications for AR15s. This authoritative book gives users the confidence and know-how to tackle everything from a simple sight install to the more challenging changing out of a barrel...and everything in between.

ITEM # AVTOPMODS

# OBSOLETES PRETENDERS AND ESTABLISHES THE NEW STANDARD FOR ARMORER'S TOOLS.



HEAVY-DUTY WRENCH FEATURES A 10-150 FT-LB RANGE.

SOLID NUT-GRIPPING STRENGTH AND ENHANCED NO-SLIP CONTROL



TITANIUM-COATED STAINLESS STEEL CONSTRUCTION

12 CROWFOOT WRENCHES & TORQUE WRENCH



ORGANIZED AND PROFESSIONAL SECURE TOOL STORAGE



PRECISE "DEEP SEAT" FITMENT

## WORLD'S FIRST PROFESSIONAL-GRADE CROWFOOT ARMORER WRENCHES.

### MASTER-FIT® 13-PIECE AR15 CROWFOOT WRENCH SET

The most comprehensive all-in-one AR15 Armorer's Torque Wrench Kit ever assembled. Master-Fit single-purpose crowfoot wrenches are made specifically for the job. Specialized for precise fitment and manipulation of MIL-SPEC and free-float barrel nuts, muzzle devices and castle nuts. Titanium-coated stainless steel construction provides tight tolerances for solid nut-gripping strength and enhanced no-slip tool control. Paired with the heavy-duty Master-Fit Torque Wrench, it takes Gun DIY® building to a new level of Master Grade quality and precision. It's time to raise your Gun Tool™ expectations and Upgrade to Master Grade®!

ITEM # AVMF13WS

# DESIGNED SPECIFICALLY FOR GUN NUTS.



**DELTA RING BARREL NUT WRENCH**



**FREE-FLOAT BARREL NUT WRENCH**



REVERSE SIDE

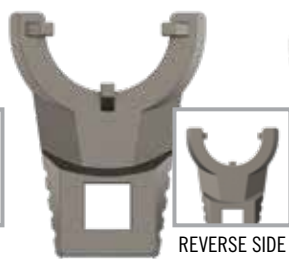

**EXTENDED & STANDARD CASTLE NUT WRENCH**



REVERSE SIDE

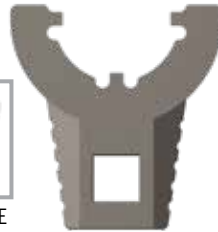

**THIN CASTLE NUT WRENCH**



**2" SPANNER WRENCH**



**3-PRONG FLASH HIDER WRENCH**



**5/8" MUZZLE DEVICE / A2 BUTTSTOCK EXTENSION TUBE WRENCH**



**3/4" MUZZLE DEVICE WRENCH**



**1-1/8" FREE-FLOAT BARREL NUT WRENCH**



**30MM FREE-FLOAT BARREL NUT WRENCH**



**1-1/4" FREE-FLOAT BARREL NUT WRENCH**



**1-5/16" FREE-FLOAT BARREL NUT WRENCH**

**SPECIALIZED WRENCHES FIT MOST COMMON AR15 ASSEMBLY NUT SIZES.**

**4 CROWFOOT WRENCHES & TORQUE WRENCH**



**MASTER GRADE A2/AR15 WRENCHES & TORQUE WRENCH**

## MASTER-FIT® 5-PIECE A2 CROWFOOT WRENCH SET

This Master-Fit crowfoot wrench set is specialized for precise fitment and manipulation of A2 barrel nuts, buttstocks, muzzle devices and castle nuts. Titanium-coated stainless steel construction provides tight tolerances for solid nut gripping strength and enhanced no-slip fitment. Paired with the heavy-duty Master-Fit Torque Wrench, it takes Gun DIY® building to a new level of Master Grade quality and precision.

ITEM # AVMF5WS

## MASTER GRADE® AR15 CROWFOOT ARMORER'S WRENCHES

### MASTER-FIT WRENCH HEADS

Now you can say, "I've got a wrench for that!" No more rigging and adapting generic wrenches to complete your builds. Master-Fit 1/2" Drive Crowfoot Wrenches are purpose built and specialized for precise fitment to confidently deliver torque to the most common MIL-SPEC and standard assembly nuts. Titanium-coated stainless steel construction provides tight tolerances for solid nut-gripping strength and enhanced no-slip tool control.

DELTA RING BARREL NUT WRENCH  
 FREE-FLOAT BARREL NUT WRENCH  
 EXTENDED & STANDARD CASTLE NUT WRENCH  
 THIN CASTLE NUT WRENCH  
 2" SPANNER WRENCH  
 3-PRONG FLASH HIDER WRENCH  
 5/8" MUZZLE DEVICE / A2 BUTTSTOCK EXTENSION TUBE WRENCH  
 3/4" MUZZLE DEVICE WRENCH  
 1-1/16" FREE-FLOAT BARREL NUT WRENCH  
 1-1/8" FREE-FLOAT BARREL NUT WRENCH  
 30MM FREE-FLOAT BARREL NUT WRENCH  
 1-1/4" FREE-FLOAT BARREL NUT WRENCH  
 1-5/16" FREE-FLOAT BARREL NUT WRENCH

ITEM # AVMFDRBNW  
 ITEM # AVMFFBNW  
 ITEM # AVMFSCNW  
 ITEM # AVMFCNW  
 ITEM # AVMF2SW  
 ITEM # AVMF3PFHW  
  
 ITEM # AVMF58MDW  
 ITEM # AVMF34MDW  
 ITEM # AVMF1116BNW  
 ITEM # AVMF118BNW  
 ITEM # AVMF30BNW  
 ITEM # AVMF114BNW  
 ITEM # AVMF1516BNW

# X3™ DRIVER ADAPTS TO MEET YOUR NEEDS.



FINE TOOTH GEAR AND RATCHETING THUMBWHEEL ALLOW FOR WORK IN CONFINED SPACES.

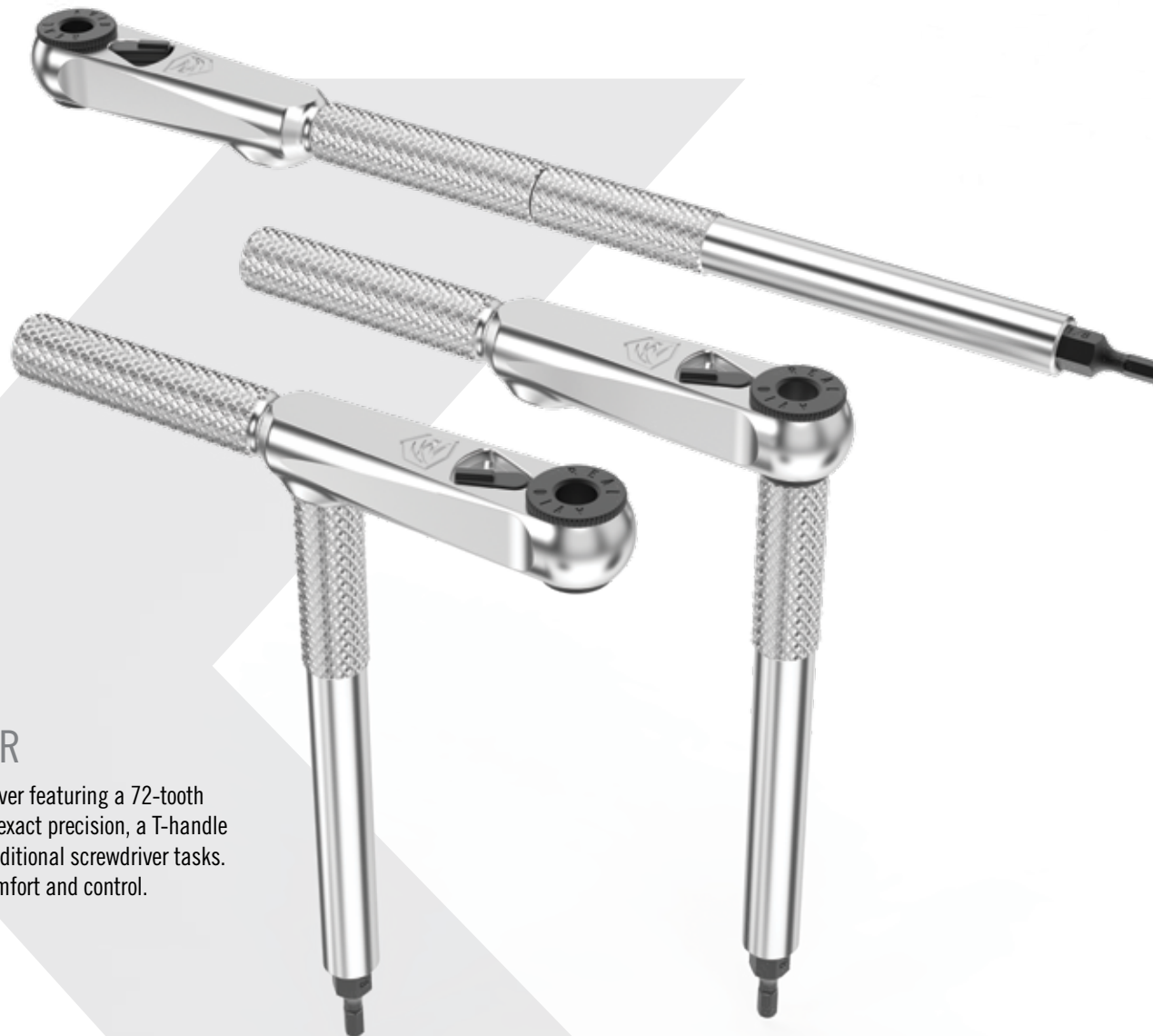

**3 PRECISION DRIVERS IN ONE.**

**T-HANDLE DRIVER**

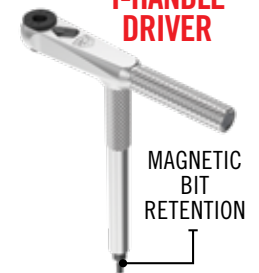

MAGNETIC BIT RETENTION

**RATCHETING DRIVER**



1/4" BIT DRIVER

**BIT DRIVER**

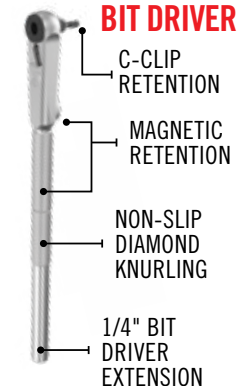

C-CLIP RETENTION

MAGNETIC RETENTION

NON-SLIP DIAMOND KNURLING

1/4" BIT DRIVER EXTENSION

# X3

COMBINATION RATCHET, T-HANDLE & SCREWDRIVER

Upgrade your toolkit with the versatile X3 Driver featuring a 72-tooth ratcheting driver for increased leverage and exact precision, a T-handle for quick adjustments and a bit driver for traditional screwdriver tasks. It's sleek design and non-slip grip ensure comfort and control.

**PATENT**

realavid.com/pat

# PRECISE, SMART, EASY TO USE. THE PERFECT GUN TOOL UPGRADE.

**17  
PIECE  
SET**

INCLUDES:  
**X3**  
COMBINATION RATCHET,  
T-HANDLE & SCREWDRIVER

PROTECTIVE,  
COMPACT  
STORAGE CASE



- X3 (3-IN-1) DRIVER**  
**15-65 IN-LB ADJUSTABLE TORQUE LIMITER**  
**INCLUDES 12 BITS + SOCKET ADAPTER**
- HEX: 7/64", 1/8", 9/64", 5/32", 3/16", 1/4"
  - ★ TORX®: T10, T15, T20, T25
  - ⊕ PHILLIPS®: #2
  - ① FLAT: 5MM
  - SOCKET ADAPTER: 1/4"
- 1/2" SOCKET

**PATENT**  
realavid.com/pat

## SMART-TORQ® ADJUSTABLE LIMITER & X3™ DRIVER KIT

Upgrade your toolkit. The Smart-Torq Adjustable Limiter is designed for precise tightening of scope rings, mounts and action screws. Integrated precision clutch adjusts from 15-65 in-lbs in 1 in-lb precise increments. The versatile X3 Driver™ features a 1/4" hex bit design with three integrated drivers: a 72-tooth ratcheting driver for increased leverage and exact precision, a T-handle for quick adjustments and a bit driver for traditional screwdriver tasks. Non-slip grip offers superior comfort and control. The kit includes a 12-piece bit set, a 1/4" hex to 1/4" square adapter and a 1/2" socket, all in a compact, protective case, perfect for home, field or range use.

ITEM # AVSTALX3KIT

## THE PERFECT UPGRADE FOR TORQUE ADJUSTMENTS ON THE GO.



**15-65  
IN-LB**

COMPACT DESIGN  
3.5" X .95"

ADJUSTS IN 1 IN-LB INCREMENTS, WITH A PRECISION CLUTCH.

EASY-TO-SELECT, PRECISE 1 IN-LB INCREMENTS

## SMART-TORQ ADJUSTABLE LIMITER

Achieve perfect scope mounting with the Smart-Torq Adjustable Limiter, designed for precise tightening of scope rings, mounts and action screws. It adjusts from 15-65 in-lbs in precise 1 in-lb increments. Compact and indispensable for firearm enthusiasts, it's perfect for home, field or range use.

ITEM # AVSTAL1565

# A FIXED SOLUTION FOR PRECISION AND RELIABILITY.

INCLUDES:  
**X3**  
COMBINATION RATCHET,  
T-HANDLE & SCREWDRIVER  
**PATENT**  
realavid.com/pat

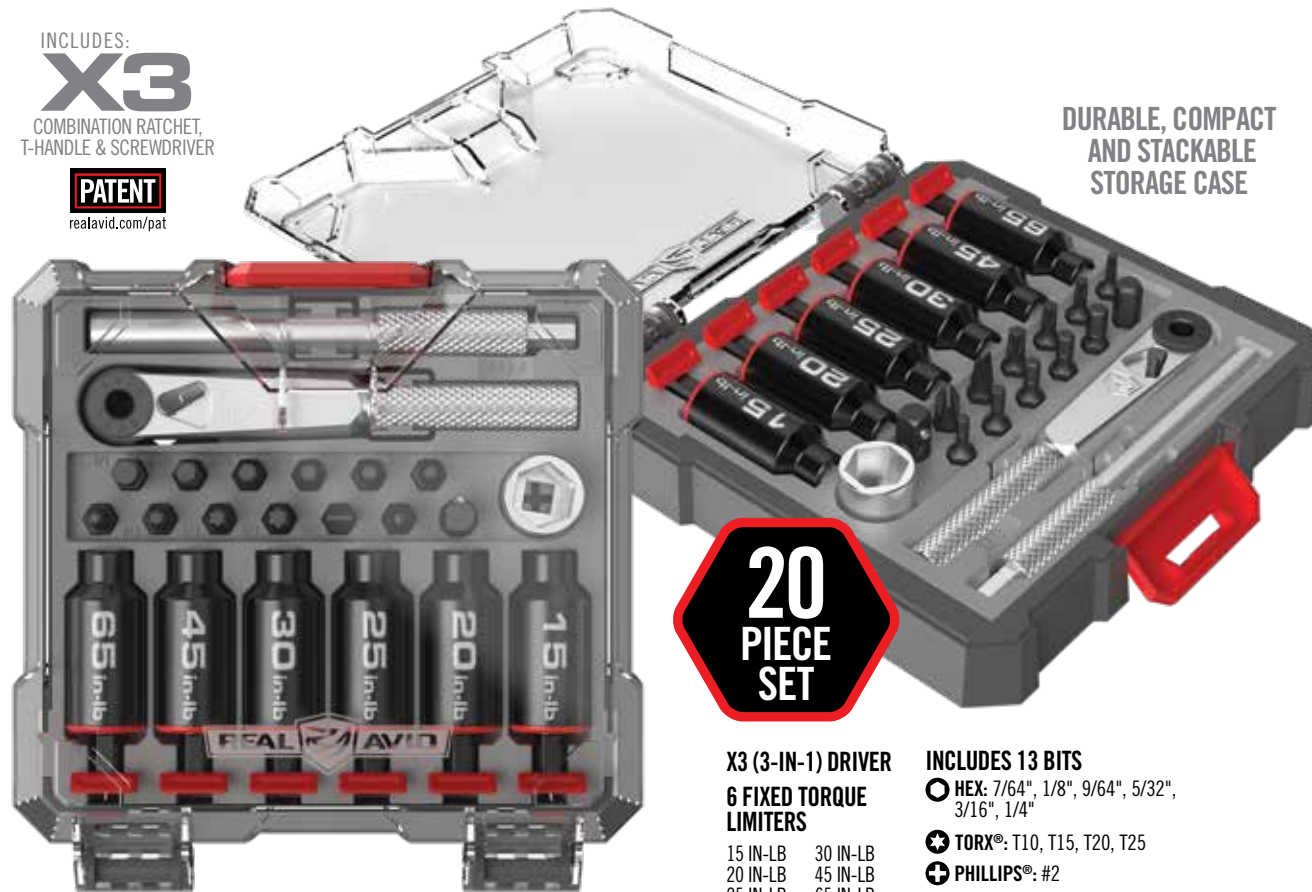

DURABLE, COMPACT  
AND STACKABLE  
STORAGE CASE

**20  
PIECE  
SET**

**X3 (3-IN-1) DRIVER**  
**6 FIXED TORQUE LIMITERS**  
15 IN-LB 30 IN-LB  
20 IN-LB 45 IN-LB  
25 IN-LB 65 IN-LB  
**1/2" SOCKET**

**INCLUDES 13 BITS**  
● **HEX:** 7/64", 1/8", 9/64", 5/32", 3/16", 1/4"  
● **TORX®:** T10, T15, T20, T25  
● **PHILLIPS®:** #2  
● **FLAT:** 5MM  
● **SOCKET ADAPTER:** 1/4"

**SIMPLE, FAST,  
NO-GUESS ACCURACY.**



## SMART-TORQ FIXED LIMITER

Professional grade Smart-Torq Fixed Limiters consistently deliver precise in-lb torque settings for scope rings, mounts and action screws. Compact design easily upgrades any toolkit.

FIXED TORQUE LIMITER — 7 IN-LB  
FIXED TORQUE LIMITER — 10 IN-LB  
FIXED TORQUE LIMITER — 12 IN-LB  
FIXED TORQUE LIMITER — 15 IN-LB  
FIXED TORQUE LIMITER — 18 IN-LB  
FIXED TORQUE LIMITER — 20 IN-LB  
FIXED TORQUE LIMITER — 25 IN-LB  
FIXED TORQUE LIMITER — 30 IN-LB  
FIXED TORQUE LIMITER — 35 IN-LB  
FIXED TORQUE LIMITER — 45 IN-LB  
FIXED TORQUE LIMITER — 50 IN-LB  
FIXED TORQUE LIMITER — 65 IN-LB  
FIXED TORQUE LIMITER — 80 IN-LB  
FIXED TORQUE LIMITER — 100 IN-LB

ITEM # AVSTFL07  
ITEM # AVSTFL10  
ITEM # AVSTFL12  
ITEM # AVSTFL15  
ITEM # AVSTFL18  
ITEM # AVSTFL20  
ITEM # AVSTFL25  
ITEM # AVSTFL30  
ITEM # AVSTFL35  
ITEM # AVSTFL45  
ITEM # AVSTFL50  
ITEM # AVSTFL65  
ITEM # AVSTFL80  
ITEM # AVSTFL100

## SMART-TORQ® FIXED LIMITER & X3™ DRIVER KIT

Professional grade Smart-Torq Fixed Limiters consistently deliver precise in-lb torque settings for scope rings, mounts and action screws. Compact design easily upgrades any toolkit. The versatile X3 Driver features: a 72-tooth ratcheting driver for increased leverage and exact precision, a T-handle for quick adjustments and a bit driver for traditional screwdriver tasks. Its sleek design and non-slip grip ensure comfort and control. This set also includes 12 driver bits, a 1/4" hex-to-square adapter and a 1/2" socket, providing valuable expanded versatility.

ITEM # AVSTFLX3KIT

# ELEVATE YOUR TOOLS WITH PRECISION AND VERSATILITY.



DURABLE, COMPACT STORAGE CASE

**13**  
PIECE SET

**PATENT**  
realavid.com/pat

#### INCLUDES 13 BITS

- **HEX:** 5/64", 3/32", 5/32", 3/16", 3.0MM, 4.0MM, 5.0MM
- ⊕ **TORX®:** T10, T15, T20, T25
- ⊕ **PHILLIPS®:** #1
- ⓪ **FLAT:** 5MM

INCLUDES:  
**X3**  
COMBINATION RATCHET,  
T-HANDLE & SCREWDRIVER

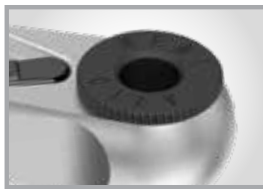

SMALL TOOTH GEAR AND RATCHETING THUMBWHEEL ALLOW FOR WORK IN CONFINED SPACES.

## X3™ DRIVER 13-PIECE GUNSMITHING BIT SET

This compact 13-piece bit set includes high-quality Torx, Phillips, metric hex and standard hex bits. Housed in a rugged, pocket-sized case, the X3 Driver is the ultimate on-the-go companion.

ITEM # AVX3GBS13



DURABLE, COMPACT STORAGE CASE

**52**  
PIECE SET

**PATENT**  
realavid.com/pat

#### INCLUDES 36 BITS

- **HEX:** 2x 1/16", 5/64", 3/32", 7/64", 1/8", 5/32", 3/16", 1/4", 2x 1.0MM, 2x 1.5MM, 2.0MM, 3.0MM, 4.0MM, 5.0MM, 6.0MM
- ⊕ **TORX®:** 2x T4, 2x T5, T10, T15, T20, T25, T27
- ⊕ **PHILLIPS®:** 2x #1, 2x #2
- ⓪ **FLAT:** 2MM, 4MM
- ⓪ **SQUARE:** #1, #2
- ⓪ **SOCKET ADAPTER:** 1/4"

#### INCLUDES 16 SOCKETS

- BRIGHT CHROME:** 3/16", 1/4", 9/32", 5/16", 11/32", 3/8", 7/16", 1/2"
- MATTE CHROME:** 6MM, 7MM, 8MM, 9MM, 10MM, 11MM, 12MM, 13MM

INCLUDES:  
**X3**  
COMBINATION RATCHET,  
T-HANDLE & SCREWDRIVER

## X3 DRIVER 52-PIECE SOCKET & GUNSMITHING BIT SET

Included is a 36-piece bit set featuring Torx, Phillips, metric hex and standard hex bits, plus a 16-piece socket set with 8 metric and 8 standard sockets. Elevate your toolkit with the precision and versatility of the X3 Driver today!

ITEM # AVX3SGBS52



DURABLE, COMPACT STORAGE CASE

**57**  
PIECE SET

**PATENT**  
realavid.com/pat

#### INCLUDES 56 BITS

- **HEX:** 2x 1/16", 5/64", 3/32", 7/64", 1/8", 9/64", 5/32", 3/16", 7/32", 15/64", 1/4", 2x 1.5MM, 2x 2.0MM, 2.5MM, 3.0MM, 3.5MM, 4.0MM, 5.0MM, 6.0MM, 7.0MM, 8.0MM
- ⊕ **TORX®:** 2x T4, 2x T5, 2x T6, 2x T8, 2x T10, 2x T15, T20, T25, T27, T30
- ⊕ **PHILLIPS®:** 2x #1, 2x #2, 2x #3
- ⓪ **FLAT:** 2x 2MM, 2.5MM, 3MM, 4MM, 5MM
- ⓪ **SQUARE:** 2x #1, 2x #2
- ⓪ **SOCKET ADAPTER:** 1/4"

INCLUDES:  
**X3**  
COMBINATION RATCHET,  
T-HANDLE & SCREWDRIVER

## X3 DRIVER 57-PIECE GUNSMITHING BIT SET

This 57-piece bit set includes—Torx, Phillips, metric hex and standard hex—providing ultimate versatility for all your fastening needs. Elevate your toolkit with the X3 Driver and experience a new standard in performance and reliability.

ITEM # AVX3GBS57

# PRECISION TORQUE DRIVER FOR FIREARMS.



EASY-TO-SELECT  
**PRECISE 1 INCH-LB**  
INCREMENTS ELIMINATES  
THE GUESSWORK OF  
OTHER WRENCHES



INCLUDES PREMIUM  
HIGH-DENSITY FOAM  
STORAGE CASE



BIT SET FITS MOST  
OPTIC MOUNTING RINGS  
AND BASE BRANDS

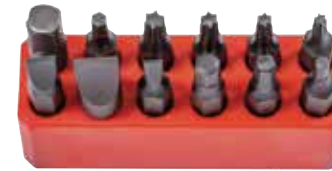

INCLUDED BITS

- T10
- T15
- T20
- T25
- 3MM HEX
- 5/32 HEX
- 3/16 HEX
- 7/64 HEX
- 90-6 FLAT
- 38-4 FLAT
- 60-5 FLAT
- SQUARE DRIVE ADAPTER BIT

**FORCE ASSIST™ DRIVER**



**FORCE ASSIST TECHNOLOGY HELPS  
TO PRECISELY TIGHTEN SCREWS**

The ergonomic, rubberized grip partnered with Force Assist makes tightening screws and fasteners to precise torque settings accurate and easy.

## MASTER GRADE 10-70 INCH-LB TORQUE DRIVER

### SMART-TORQ®

The most precise and technically-advanced torque driver for guns. Specifically developed for optics mounting and gun builds. Discrete inch-lb increment settings provide spot-on torque adjustments. Comfortable ergonomic grip, palm-friendly spin top and Force Assist make precise torque adjustments easy. Functionally-intuitive torque setting with visual, tactile and audible feedback provides assurance. To get you started, Smart-Torq comes with 12 of the most commonly used scope mounting and gun bits. Never over torque a scope ring again!

ITEM # AVSTORQ

# ADVANCED GUNSMITHING DRIVER WITH FORCE ASSIST.™

87 STANDARD & METRIC BLACK OXIDE-COATED SQUARE CUT HOLLOW GROUND GUN BITS

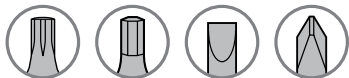

PALM-FRIENDLY SPIN TOP, COMFORTABLE ERGONOMIC GRIP



SMALL DRIVER FOR TIGHT SPACES. DOUBLES AS FORCE ASSIST LEVER

FORCE ASSIST TECHNOLOGY HELPS LOOSEN STUCK SCREWS AND PRECISELY TIGHTEN SCREWS

RUGGED CASE WITH SLIDE LOCKS



**PATENT**  
realavid.com/pat

90-PIECE GUNSMITHING KIT WITH FORCE ASSIST LED BIT DRIVER

## SMART DRIVE® 90

Smart Drive 90 is an advanced gunsmithing driver set. The main driver features a magnetic bit holder, rubber grip texture, jewelers spin top & 360° LED light. It partners with the small “close quarters” driver to create Force Assist. Force Assist is a proprietary system that allows users to loosen frozen-in-place screws as well as precisely tighten screws.

ITEM # AVSD90



**360° LIGHT**  
ILLUMINATES DARK, HARD-TO-SEE SCREWS

ONE CLICK EQUALS 1 INCH-LB  
10 TO 70 IN-LBS



**PATENT**  
realavid.com/pat

PRECISION MOUNT OPTICS, GUN STOCKS AND ACCESSORIES

# MASTER GRADE® GUNSMITHING DRIVER & BIT SET.

## SMART-TORQ® & DRIVER MASTER SET

This intelligently-designed Master Set includes both the Smart-Torq and Smart Drive gunsmithing drivers. With ergonomic comfort grips, both drivers fully integrate with the multi-purpose Force Assist driver. Smart-Torq features easy-to-see and set 1 in-lb increments. For non-torque applications, the Smart Drive will be your go-to for not only gunsmithing work, but any tasks around the house or shop. Smart Drive has a free-spinning cap for applying additional downward pressure and an LED light for dark spaces. Completing the set are 83 standard and metric black oxide-coated gun bits. Gun bits are hollow ground and square cut for precise fitment.

ITEM # AVSTDMS

# EXPANDS TO SECURELY FIT THE MAGWELL.

**BUILT AROUND A GLOCK BUT PERFECTED FOR AN AR9.**

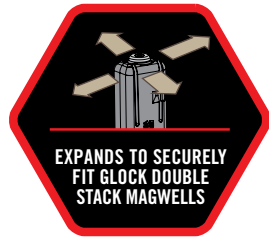

EXPANDS TO SECURELY FIT GLOCK DOUBLE STACK MAGWELLS

COMPATIBLE WITH 9MM/.357/.40 CAL MAGWELLS

**PLUS**  
AR9 PIVOT LOCK SECURELY HOLDS UPPER OPEN FOR CLEANING



DOUBLE-STACK GLOCKS ONLY

**PATENT**  
realavid.com/pat

## SMART-FIT® VISE BLOCK FOR AR9

The Smart-Fit Vise Block for AR9 is a first-of-its-kind firearm maintenance tool designed to work with Glock mag fed AR9/PCC (Pistol Caliber Carbine), Glocks and Glock clone pistols. This vise block is designed to provide a secure, hands-free way to quickly assemble, disassemble, repair and maintain your AR9 or Glock. The expanding design and magazine lock relief allows for a perfect fit with all Glock double-stack 9mm/.357/.40 cal magwell firearms. Insert the block into the magwell and rotate the adjustment handle to tighten for a secure fit. For hassle-free cleaning, we include the Pivot Lock for hands-free access to the chamber and barrel of your AR9.

ITEM # AVGLOCKSFBV

**DESIGNED TO FIT ALL MIL-SPEC AR15 MAGWELLS.**

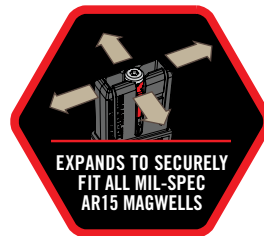

EXPANDS TO SECURELY FIT ALL MIL-SPEC AR15 MAGWELLS



**PLUS**  
AR15 PIVOT LOCK SECURELY HOLDS UPPER OPEN FOR CLEANING



ADJUSTABLE FIT BLOCK FOR ROCK-SOLID SUPPORT TO CLEAN, MAINTAIN OR BUILD YOUR AR15.

## SMART-FIT AR15 VISE BLOCK

**PATENT**  
realavid.com/pat

The Smart-Fit AR15 Vise Block is the last lower vise block you'll ever need. The patented block expands to fit any .223 cal / 5.56mm AR15 magwell, making loose, sloppy fitting blocks a thing of the past. Insert the block into the magazine well and simply rotate the adjustment handle to tighten the fit.

ITEM # AVAR15SFVB

**AR10 SLEEVE SLIDES OVER AR15 VISE BLOCK.**

NOT COMPATIBLE WITH AR10B

## SMART-FIT AR15 VISE BLOCK WITH SLEEVE FOR AR10\*\*

The Smart-Fit AR15 Vise Block and Vise Block Sleeve for AR10, DPMS LR-308 and SR-25 is the best lower receiver vise block you'll ever use. Magwell sizes have a notoriously wide range of tolerances, and traditional blocks create wiggle and wobble on a gun vise. Smart-Fit's design solves that. It expands to fit all MIL-SPEC AR15s, AR10s and similar magwells, making loose, sloppy-fitting blocks a thing of the past.

ITEM # AV1015SFVB

**PATENT**  
realavid.com/pat



**PATENT**  
realavid.com/pat

## SMART-FIT VISE BLOCK SLEEVE FOR AR10\*\*

The Smart-Fit Vise Block Sleeve for AR10 was designed to slide over the Real Avid Smart-Fit AR15 Vise Block to help eliminate wobble when working on large frame rifles.

ITEM # AVAR10SFVBS

# MASTER GRADE® ARMORER'S WRENCH FOR GUN DIY.®

**PATENT**

realavid.com/pat



FREE-FLOAT BARREL NUT WRENCH (FEATURES 10 POSTS FOR BEST-IN-CLASS STRENGTH)



REVERSE SIDE OF MIL-SPEC BARREL NUT WRENCH

ERGONOMIC DESIGN LETS YOU APPLY TORQUE WITHOUT HURTING YOUR HAND

## ARMORER'S MASTER WRENCH®

The Real Avid Armorer's Master Wrench features best-in-class strength, precision fitment and ergonomic intelligence. Wrenches seat squarely for a no-slip fit on stubborn barrel nuts, castle nuts, muzzle brakes and fixed stock receiver extensions. Industry-first torque wrench attachment location is optimally positioned to provide consistent torque poundage for all nuts. As a bonus, interchangeable hammer heads make the Armorer's Master Wrench a "Master" hammer as well!

ITEM # AVAR15AMW

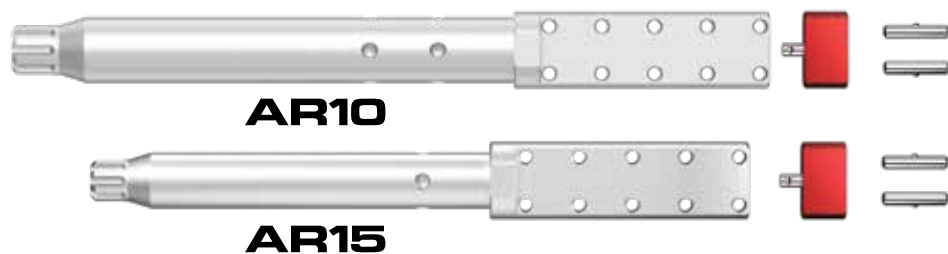

AR10

AR15

**PATENT**

realavid.com/pat

## LUG-LOK UPPER VISE BLOCK™

We designed an upper block that leverages the strongest part of the gun – the barrel lugs inside the star chamber. The Lug-Lok is precision machined and precisely fits into all MIL-SPEC uppers. It mates perfectly with the barrel lugs, while allowing you to rotate the upper to be able to work on different sides.

LUG-LOK UPPER VISE BLOCK - AR15  
LUG-LOK UPPER VISE BLOCK - AR10

ITEM # AVAR15LLVB  
ITEM # AVAR10LLVB

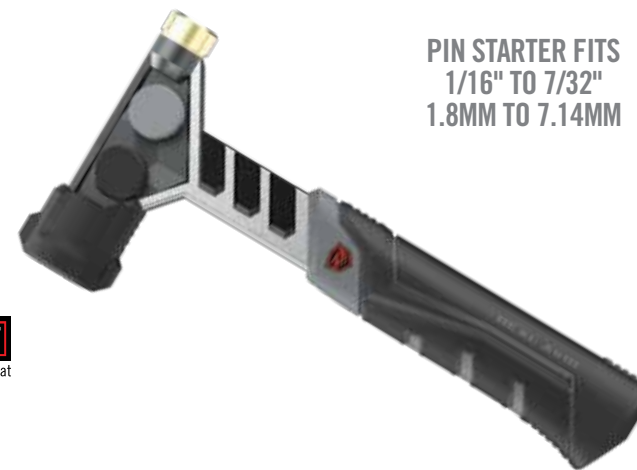

PIN STARTER FITS  
1/16" TO 7/32"  
1.8MM TO 7.14MM



INTEGRATED  
MAGNETIC  
PIN  
STARTER

**PATENT**

realavid.com/pat

## ARMORER'S MASTER HAMMER™

Tested and influenced by gunsmiths, the Armorer's Master Hammer is a 22-ounce, 9-1/2" long, forged hammer with full-length tang for a perfect balance and ideal ergonomics for precise control. A removable soft blow hammer head cover and interchangeable hammer heads with integrated storage make it easy to install the correct hammer head for the application. Stored in the handle is a removable, stainless steel, magnetic pin starter to provide a helping hand when building or modifying firearms.

ITEM # AVARMHAM



INTEGRATED MAGNETIC  
PIN  
STARTER

ARMORER'S MASTER  
HAMMER

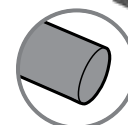

STANDARD  
PIN PUNCH

2x 1/16", 5/64", 3/32" 1/8", 9/64", 5/32",  
3/16", 7/32", 1/4", 9/32" steel punches

## ARMORER'S MASTER HAMMER AND ACCU-PUNCH® 11-PIECE STANDARD PIN PUNCH SET

The Armorer's Master Hammer and Accu-Punch 11-piece Standard Pin Punch set, crafted for expert gunsmiths. The Armorer's Master Hammer boasts a balanced 22-ounce forged hammer with a full-length tang for precision control. It comes with interchangeable hammer heads and a magnetic pin starter for effortless adaptation and accurate firearm modifications. The Accu-Punch set features hardened steel punches with nickel plating for corrosion resistance and a hex-shaped handle with O-rings for precise control. Elevate your gunsmithing with these essential tools, designed for unmatched precision and durability.

ITEM # AVAMHAPS

**PATENT**

realavid.com/pat

# DESIGNED FROM THE GROUND UP TO WORK BETTER ON GUNS.

## ACCU-PUNCH® HAMMER & PIN PUNCH SETS

Gunsmithing hammers and punches are core tools needed to modify or disassemble firearms. Most sets available today are generic, repurposed hardware sets. Accu-Punch Hammer & Punch Sets are designed from the ground up to work better on guns. The hammer features an ergonomic grip and perfectly-balanced weight to give both precise control for tapping tiny pins and optimal force for those that need a little "persuasion". Punches are made of hardened steel with a nickel plating to resist corrosion as well as hex-shaped handles and rubber O-rings for precise control. The proprietary Pin Alignment Tool makes aligning and starting tiny pins both easy and accurate. These professional-grade gunsmithing sets are organized in an uber-tough stand-up case.

## GUNSMITHING PIN PUNCH SETS WITH PIN ALIGNMENT TOOL.



STANDARD  
PIN PUNCH  
SET



STANDARD  
BRASS & STEEL  
PIN PUNCH  
SET



ROLL PIN  
PUNCH SET



STANDARD  
& ROLL PIN  
PUNCH SET  
FOR AR15

### STANDARD

COMPLETE SET OF STANDARD-SIZED GUN PIN PUNCHES

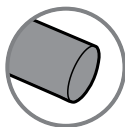

STANDARD  
PIN PUNCH

- Gunsmithing hammer with rubberized, ergonomic grip
- 4 interchangeable hammer heads: rubber, brass, steel & nylon
- Pin Alignment Tool
- 1/16", 5/64", 3/32", 1/8", 9/64", 5/32", 3/16", 7/32", 1/4", 9/32" steel punches
- 5/16" nylon finishing punch
- Stand-up case

ITEM # AVHPS

### BRASS & STEEL

COMPLETE SET OF STANDARD-SIZED GUN PIN PUNCHES

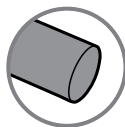

STANDARD  
PIN PUNCH

- Gunsmithing hammer with rubberized, ergonomic grip
- 4 interchangeable hammer heads: rubber, brass, steel & nylon
- Pin Alignment Tool
- 1/16", 5/64", 3/32" steel punches and 1/8", 9/64", 5/32", 3/16", 7/32", 1/4", 9/32" brass punches
- 5/16" nylon finishing punch
- Stand-up case

ITEM # AVHPS-B

### ROLL PIN

INCLUDES ALL STANDARD-SIZED ROLL PIN PUNCHES NEEDED FOR GUNS

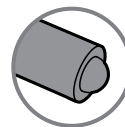

ROLL PIN  
PUNCH

- Gunsmithing hammer with rubberized, ergonomic grip
- 4 interchangeable hammer heads: rubber, brass, steel & nylon
- Pin Alignment Tool
- Roll pin punches 1/16", 5/64", 3/32", 1/8", 9/64", 5/32", 3/16", 7/32", 1/4"
- 5/16" nylon finishing punch
- Stand-up case

ITEM # AVHPS-RP

### AR15

INCLUDES EVERY STANDARD & ROLL PIN PUNCH FOR AR15

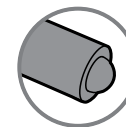

ROLL PIN  
PUNCH

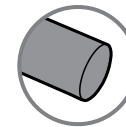

STANDARD  
PIN PUNCH

- Gunsmithing hammer with rubberized, ergonomic grip
- 4 interchangeable hammer heads: rubber, brass, steel & nylon
- Pin Alignment Tool
- Standard pin punches 3/32", 1/8", 5/32"
- Roll pin punches 1/16", 5/64", 1/8"
- Staking punch
- 3/32" bolt catch roll pin starter & roll pin punch
- 5/16" nylon finishing punch
- Stand-up case

ITEM # AVHPS-AR

# THE MOST FREQUENTLY USED GUNSMITHING PIN PUNCHES.



**STANDARD**



**ROLL PIN**



**BRASS & STEEL**

## ACCU-PUNCH® 11-PIECE PUNCH SETS

The Accu-Punch 11-Piece Punch Sets are the go-to gunsmithing pin punches for firearm enthusiasts. Crafted from hardened steel with a corrosion-resistant nickel plating, these Master Grade® sets ensure precise control with hex-shaped handles and rubber O-rings. These comprehensive kits are labeled, housed in a sturdy case and cater to every firearm modification need. Elevate your gunsmithing experience with the Accu-Punch 11-Piece Punch Sets—precision and durability at your fingertips.

ACCU-PUNCH 11-PIECE STANDARD PIN SET  
 ACCU-PUNCH 11-PIECE ROLL PIN SET  
 ACCU-PUNCH 11-PIECE STANDARD BRASS & STEEL PIN SET

ITEM # AVAPK-S  
 ITEM # AVAPK-RP  
 ITEM # AVAPK-B



## BOLT CATCH PUNCH SET

Two punches, one simple solution to the difficult-to-access bolt catch retaining pin. The orientation of the pin, close proximity to the lower receiver, distance required to safely punch a pin and the difficulty in getting the pin started makes it a real pain with standard punches.

ITEM # AVBCPS

## SPECIALIZED AR15 BOLT CATCH PIN STARTER & PIN PUNCH SET



## INCLUDES EVERY STANDARD & ROLL PIN PUNCH FOR GUNS

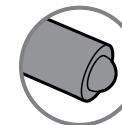

ROLL PIN PUNCH

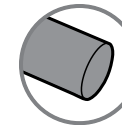

STANDARD PIN PUNCH

- Standard pin steel punches 1/16", 5/64", 3/32", 1/8", 9/64", 5/32", 3/16", 7/32", 1/4", 9/32"
- Roll pin punches 1/16", 5/64", 3/32", 1/8", 9/64", 5/32", 3/16", 7/32", 1/4", 9/32"
- Brass pin punches 1/8", 9/64", 5/32", 3/16", 7/32", 1/4", 9/32"
- 3/32" bolt catch roll pin starter & roll pin punch
- Staking punch
- 5/16" nylon finishing punch
- Pin Alignment Tool

## ACCU-PUNCH MASTER SET

Gunsmithing punches are core tools needed to modify or disassemble firearms. Accu-Punch Master Set with standard, roll pin, brass and specialty punches is designed from the ground up to work better with firearms. Non-brass punches are made of hardened steel with a nickel plating to resist corrosion. All punches have hex-shaped handles and rubber O-rings for precise control. The proprietary Pin Alignment Tool makes aligning and starting tiny pins both easy and accurate.

ITEM # AVMAPS

# WORKS WITH MOST PISTOLS, LONG GUNS AND GUN PARTS.

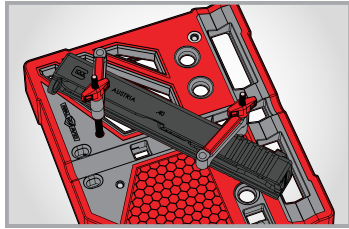

WORK ON ANY PISTOL SLIDE  
IN ANY POSITION

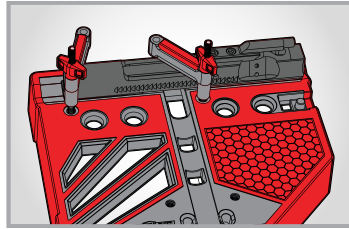

CLAMP DOWN AND CHANGE  
OUT GAS KEYS ON ALL BCGS

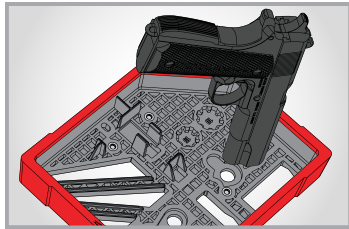

EASILY REMOVE 1911 BUSHINGS

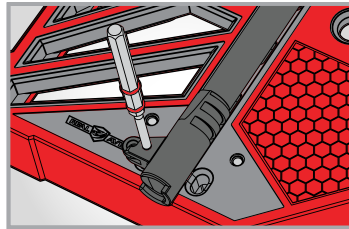

WORK ON PISTOL AND  
LONG GUN BARRELS

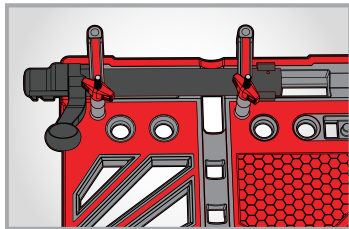

QUICKLY CLAMP DOWN BOTH LONG AND  
SHORT ACTIONS FOR TEAR DOWN

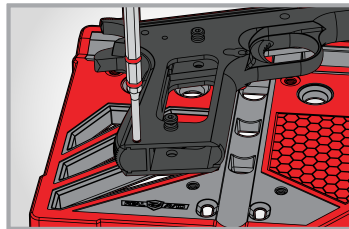

TEAR DOWN OR WORK ON  
ANY PISTOL FRAME

14 HOLES AND  
2 GROOVES  
POSITIONED  
OPTIMALLY FOR  
FLEXIBILITY

SMART-BLOCK CLAMPS FIRMLY  
HOLD PARTS IN PLACE, ENSURING  
STABILITY DURING PIN PUNCHING.

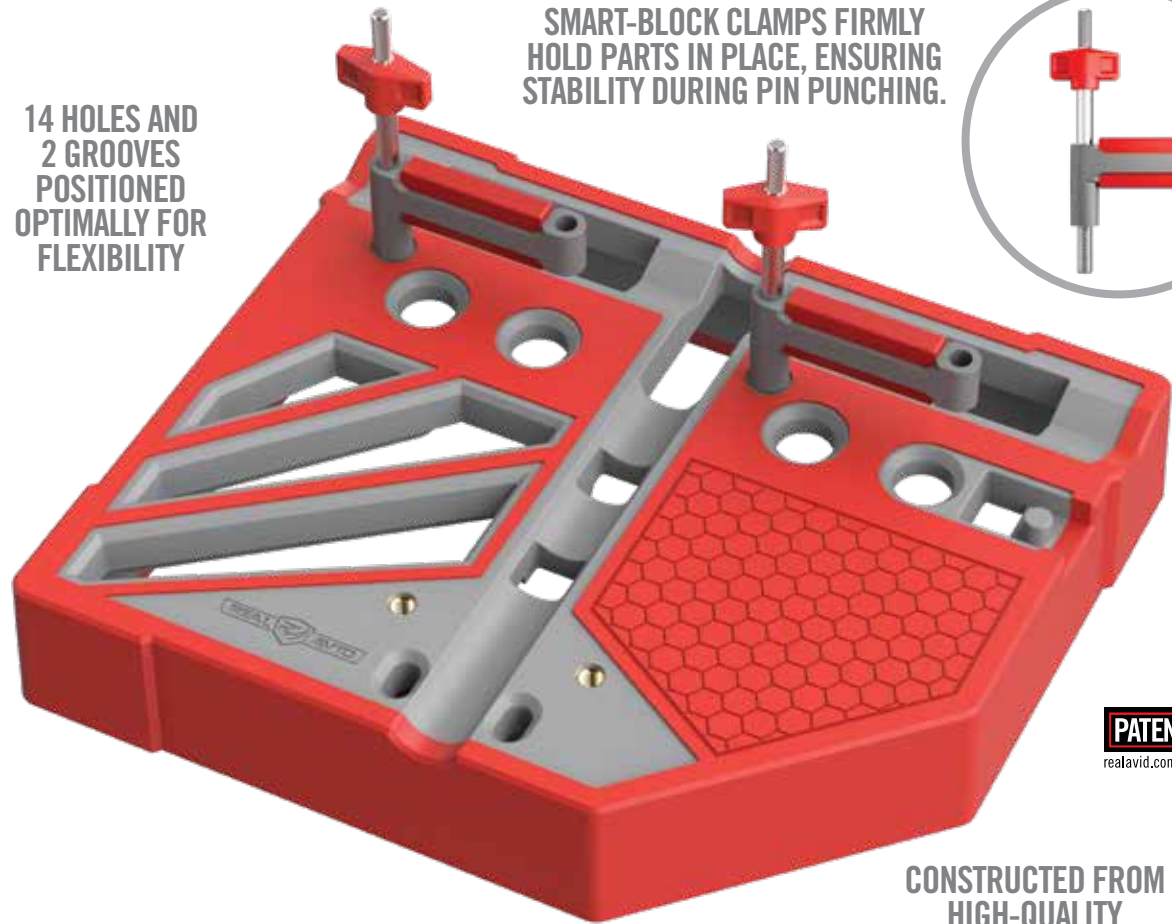
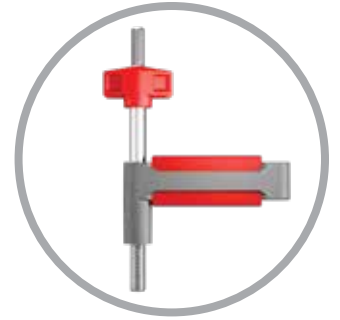

**PATENT**  
realavid.com/pat

CONSTRUCTED FROM  
HIGH-QUALITY  
ENGINEERING-GRADE RESIN



## MASTER BENCH BLOCK® PRO

With 14 strategically placed holes, 2 grooves and a larger design, precise pin alignment is made easy for all firearms. This block was constructed with utmost attention to detail for those looking to clean, repair or modify their firearms. The three elongated slots quickly align with compact- to full-size pistols. Both the vertical and horizontal grooves offer the properly needed length and cutouts for work to be performed on long and short action bolts. To help secure parts, frames or barrels firmly in place, two Smart-Block Clamps have been incorporated into the block, allowing the end user to focus purely on the task at hand. Mounted inside are two strong magnets that grasp any pin you punch out and hold it securely to the block.

ITEM # AVMBBPRO

# ALL-IN-ONE BENCH BLOCK, HAMMER AND PUNCH SET.

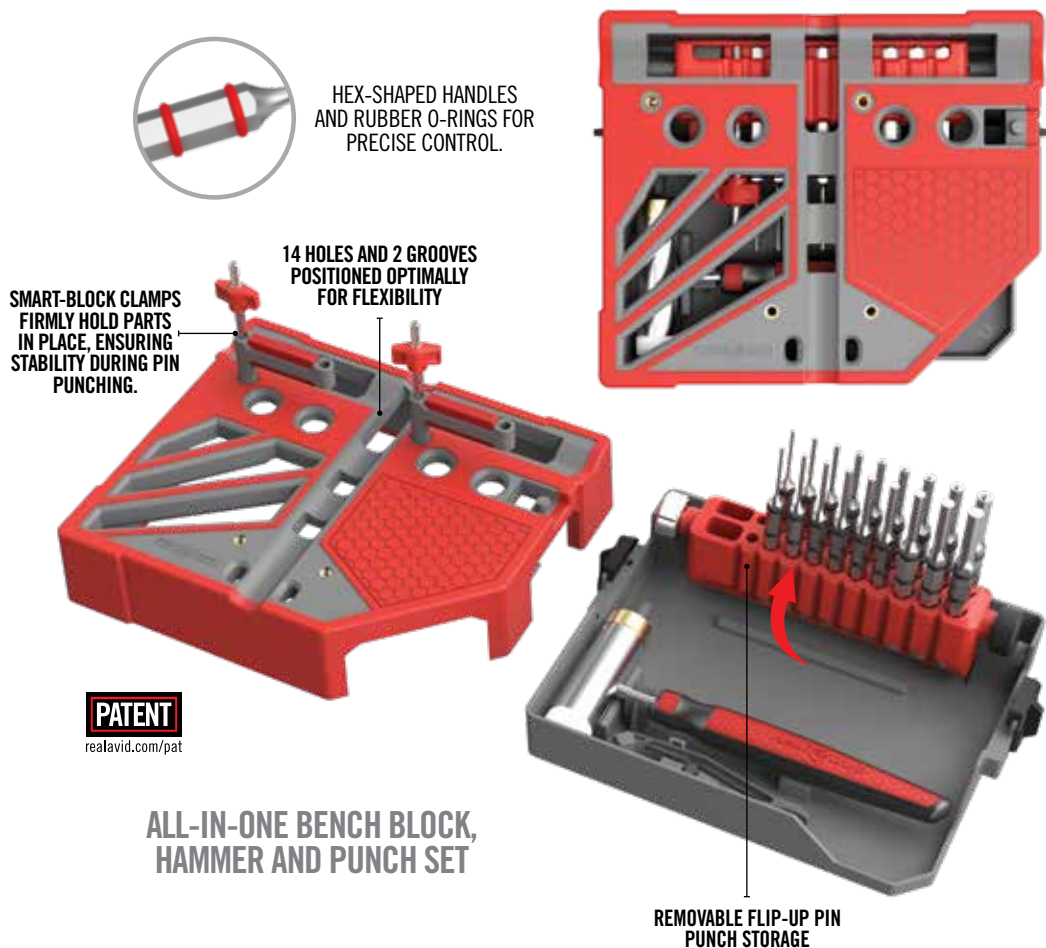

**PATENT**  
realavid.com/pat

**ALL-IN-ONE BENCH BLOCK,  
HAMMER AND PUNCH SET**

## MASTER BENCH BLOCK® PRO-KIT

The Master Bench Block Pro-Kit is a comprehensive pin punching solution that simplifies your work. This all-in-one set includes 18 hardened steel punches and an ergonomic hammer with interchangeable heads stored within a spacious bench block. With 14 strategically placed holes, 2 grooves and a larger design, precise pin alignment is made easy for all firearms. The three elongated slots quickly align with compact- to full-size pistols. To help secure parts, frames or barrels firmly in place, two Smart-Block Clamps have been incorporated into the block, allowing the end user to focus purely on the task at hand. When the work is done, store all your tools in the integrated storage tray for an easy storage solution.

ITEM # AVMBBPKIT

# THE MOST COMPREHENSIVE AR15 BENCH BLOCK, EVER.



**PATENT**  
realavid.com/pat

## MASTER BENCH BLOCK - AR15

The Master Bench Block - AR15 holds 5 key AR15 components in 8 different orientations to allow you to knock out and install up to 14 different pins. Clear, engraved labels tell you what component fits where, and what size punch you'll need to knock out the pins. The biggest innovation is mounted inside – four strong magnets immediately grasp any pin you punch out and hold it securely to the block.

ITEM # AVAR15MBB

## NON-SLIP, MAGNETIC UNIVERSAL PIN PUNCH BLOCK



**PATENT**  
realavid.com/pat

## SMART BENCH BLOCK®

Made from engineering-grade resin, this intelligently-designed gunsmith block helps protect gun finishes. The non-slip outer ring keeps the block from sliding on tables or benches while driving pins. An embedded magnet captures and holds driven pins so that they won't roll away. A rounded slot seats barrels and gun slides for increased stability. Designed to work with most guns.

ITEM # AVSBBLK

# UPGRADE YOUR GUN BUILDING EXPERIENCE.



**OVERSIZED, PROTECTIVE MAT WITH PARTS AND TOOL ORGANIZATION**



## MASTER ARMORER'S MAT®

The Master Armorer's Mat is the ultimate solution for your gun building projects. This massive mat will protect your large gun parts while the added organization trays will hold every medium and small component, making sure you don't lose any parts in the process.

ITEM # AVMAM-AR



**ERGONOMIC AR15 DELTA RING RETRACTOR**

## EASY-GRIP™ HANDGUARD REMOVAL TOOL

The name says it all. Ergonomic grips make one-handed changing of handguards on AR15s and M16s a breeze. Simply hook to the empty magwell, place the contoured rods around the Delta Ring, squeeze the handles and pull down to compress the Delta Ring. Remove the handguard with your free hand. It's that simple.

ITEM # AVEGHRT

# THE FASTEST WAY TO INSTALL A PIVOT PIN.



## PIVOT PIN TOOL FOR AR10\*\*

How can such a small task cause such frustration? The AR10 Pivot Pin Tool gives you a third hand to turn the fumble-finger, pin-launching, pain-in-the-neck task into a quick breeze. 1-2-3-4 done, it's that simple. Easily install the AR10 Pivot Pin in less than 60 seconds.

ITEM # AVAR10PPT

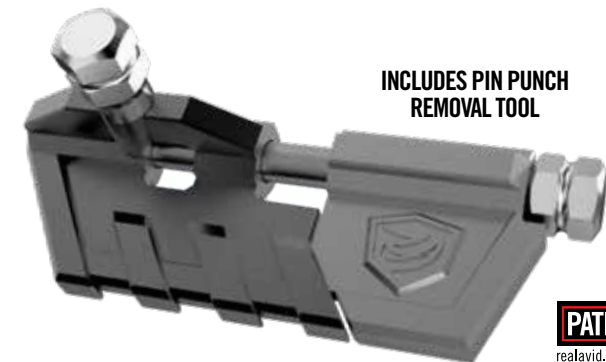

**INCLUDES PIN PUNCH REMOVAL TOOL**



## AR15 PIVOT PIN TOOL-PRO™

Highly engineered to turn a frustrating task into a quick and painless operation. The larger, all-metal construction provides extreme durability, precise fitment and ease of use with all AR15s.

ITEM # AVARPPPTRO

## AR15 PIVOT PIN TOOL

How can such a small task cause such frustration? This brilliant little tool gives you an extra hand to turn the fumble-finger, pin-launching, pain-in-the-neck task into a quick breeze. 1-2-3-4 done, it's that simple.

ITEM # AVAR15PPT

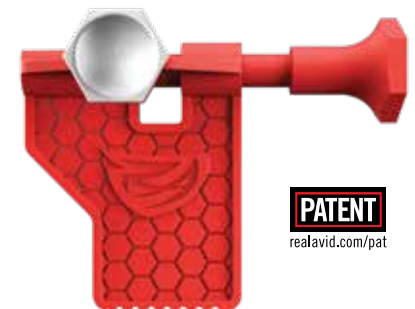

# KICKS LESSER PUSHERS TO THE BACK OF THE BENCH.

**PATENT**  
realavid.com/pat



POWERFUL  
TORQUE  
CONTROL

## REVERSIBLE PRESS BLOCK

FITS ANY DOVETAIL SLOT DOWN TO 5/32" (4MM) WIDE

## PRECISION-ENGINEERED SIGHT CHANGER

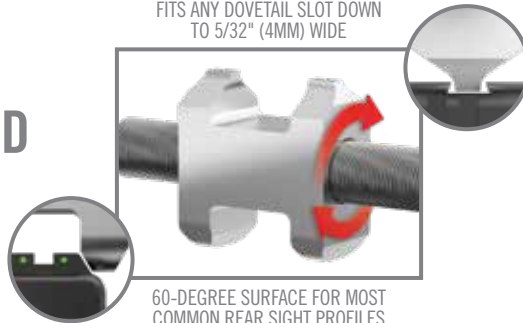

60-DEGREE SURFACE FOR MOST COMMON REAR SIGHT PROFILES

## MASTER SIGHT PUSHER®

The Master Sight Pusher is a professional-grade tool that makes quick work of changing pistol sights while protecting both gun slides and the sights themselves. Heavy-duty, built to last and smartly designed to work on most modern pistol sights. The press block features multiple contact surfaces for almost all size and style of press-fit dovetail slots and sight profiles. Adjustable polymer contact surfaces securely hold both 1911 and flat bottom pistol slide styles.

ITEM # AVMSP

# EASILY AND SAFELY CHANGE PRESS-FIT SIGHTS ON GLOCKS.

4MM PRESS BLOCK TOOTH CONNECTS WITHIN THE SIGHT'S DOVETAIL SLOT

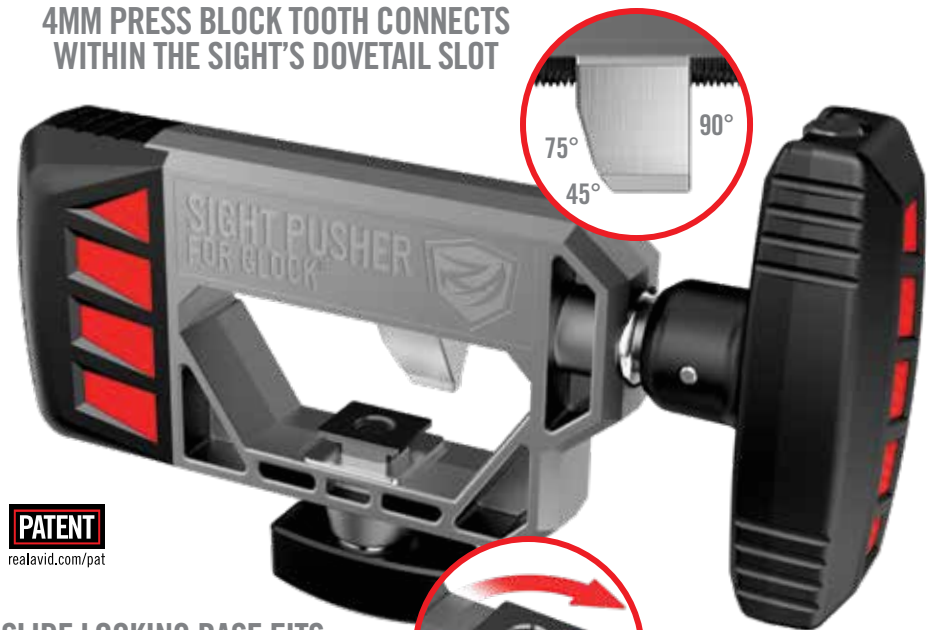

**PATENT**  
realavid.com/pat

SLIDE LOCKING BASE FITS SUBCOMPACT, COMPACT, STANDARD AND COMPETITION GLOCK SLIDES

## SIGHT PUSHER FOR GLOCK\*

The Sight Pusher for Glock is a professional-grade tool that makes quick work of changing Glock pistol sights while protecting both gun slides and the sights themselves. Heavy-duty, built to last and smartly designed to work on all Glock models, factory and aftermarket Glock sights. The oversized ergonomic Easy Torque™ Handle partners with extra-fine drive threads to provide maximum force with minimal effort when removing and installing Glock sights. A specially-designed press block features multiple contact surfaces to accommodate all Glock sights while applying maximum force to the actual dovetail surface at the optimal leverage point. The slide locking base securely anchors all sizes of Glock slides into place.

ITEM # AVGLOCKSP

\*DISCLAIMER: This product is not manufactured, authorized, endorsed, or warranted by GLOCK. GLOCK does not warrant or represent that this product is compatible with GLOCK pistols. "GLOCK" is a federally registered trademark of GLOCK, Inc. and is one of many trademarks owned by GLOCK, Inc. and GLOCK Ges.m.b.H. New Revo Brand Group, LLC, d/b/a Real Avid is not affiliated in any manner with, or otherwise endorsed by, GLOCK, Inc. or GLOCK Ges.m.b.H.

# THE MOST MODERN, ACCURATE & SIMPLE WAY TO MOUNT SCOPES.

## MOUNT. LEVEL. SIGHT.

1. SET THE BASE – LEVEL THE RETICLE
2. TORQUE DOWN SCOPE RINGS
3. BORE SIGHT – GET ON PAPER FAST



**LEVEL-RIGHT® PRO**  
MASTER GRADE PRECISION RETICLE LEVEL



**SMART-TORQ®**  
MASTER GRADE 10-70 INCH-LB  
TORQUE DRIVER



**VIZ-MAX  
BORE  
SIGHTER®**  
MASTER GRADE LASER  
BORE SIGHTER



### MASTER GRADE® SCOPE MOUNTING & BORE SIGHTING KIT

Properly mounting a new scope requires specific tasks and tools to do the job right. First and foremost is setting your reticle level. Secondly, applying the correct torque to the ring and base screws to stabilize the mount without crushing the tube. Lastly, is sighting in and getting on paper fast to save time and ammo. This kit contains the Best Tools for the Job with the Level-Right Pro, Smart-Torq and Viz-Max Bore Sighter. Upgrade to Master Grade®. Mount. Level. Sight.

**PATENT**  
realavid.com/pat

# GET ON TARGET FASTER!

## MASTER GRADE® LASER BORE SIGHTER

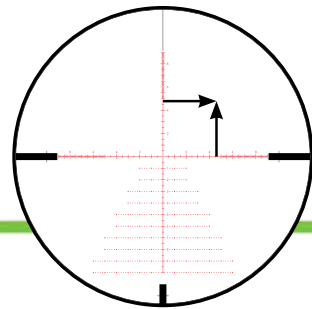

MAGNETICALLY ATTACH VIZ-MAX BORE SIGHTER TO END OF BORE. USE SCOPE TURRETS TO ALIGN CROSSHAIRS WITH PROJECTED BEAM ON TARGET. REMOVE AND BEGIN SHOOTING.

**PATENT**  
realavid.com/pat



PREMIUM HIGH-DENSITY FOAM CASE

## SAVE TIME AND AMMO

### VIZ-MAX BORE SIGHTER®

Viz-Max Bore Sighter is a revolutionary, yet uncomplicated next-generation instrument. No more fumbling with extra pieces and underpowered lasers to find your mark. Housed in the rugged and protective exoskeleton is a precision-machined, factory-calibrated green laser. The laser projects a powerful, perfect circle using the brightest daylight visible color in the spectrum. It provides maximum visibility and quick acquisition. The bore attachment is fast and easy with the hold-fast neodymium magnet. Features 30-second auto-off functionality.

ITEM # AVVMB5

# MAXIMIZE ACCURACY AT ALL DISTANCES.

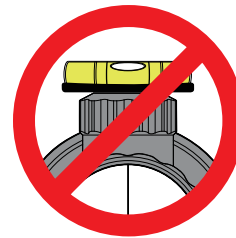

A LEVEL TURRET DOES NOT ENSURE A LEVEL RETICLE

## MASTER GRADE PRECISION RETICLE LEVEL

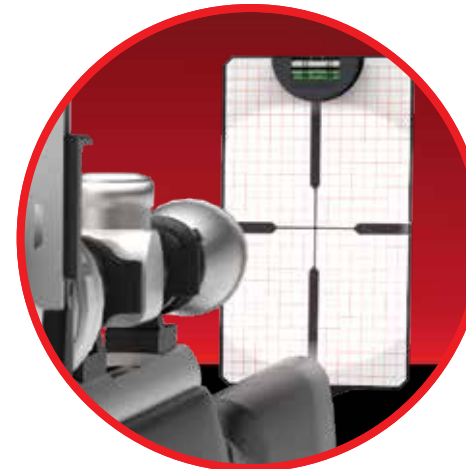

THE EASIEST, MOST ACCURATE WAY TO ENSURE YOUR SCOPE IS PROPERLY ALIGNED.

**PATENT**  
realavid.com/pat

### LEVEL-RIGHT® PRO

Correctly mounting a scope so it's level to the gun's receiver is critical to getting maximum accuracy from your rifle. A level scope means that the reticle (crosshairs) will be perfectly aligned with the rifle bore. A level reticle is critical for long-range accuracy. Balancing small levels on scope turrets and gun receivers has been a commonly-accepted practice for years. Not only is this a clumsy process, it's wrong. The turret on most scopes is not perfectly aligned with the reticle, so even if your turret is level to the gun, your scope may not be. Level-Right Pro changes all that by simplifying scope alignment in 4 easy steps. Accurate and intuitive, this time saving instrument quickly aligns the actual scope reticle to the horizontal gun plane (regardless of turret alignment), which is key to the long-range accuracy of your rifle. Level-Right Pro helps you quickly and confidently mount a scope for maximum accuracy.

ITEM # AVLVLR-P

# GO ANYWHERE. CLEAN ANYWHERE.

## MOBILE WORKSTATION

180 LUMEN WORK LIGHT WITH 3 SELECTABLE SETTINGS TO ILLUMINATE DARK, HARD-TO-SEE AREAS.

**GUN GRIPPER™**  
FORM-FITTING RETENTION FOR A TIGHT GRIP

MOBILE WORKSTATION WITH GUN GRIPPER TECHNOLOGY INCORPORATED INTO THE YOKES WRAP AROUND DIFFERENT CONTOURED BARRELS AND HANDGUARDS FOR EASY ONE-HANDED SECUREMENT.

FOUR CORNER SMART-DOCKS

QUICK-CONNECT CLIP

**SMART ASSIST**

EQUIPPED WITH SPECIALIZED TOOLS TO PROFESSIONALLY CLEAN & MAINTAIN YOUR FIREARMS.

# HIGH-PERFORMANCE, ALL-IN-ONE, GUN CLEANING KIT IN A MOBILE WORKSTATION.

## RIFLE

.22 / .223 CAL / 5.56MM  
.243 CAL / 6MM, .260 CAL / 6.5MM  
.270 CAL, .284 CAL / 7MM  
.30 CAL / 7.62MM

## HANDGUN

.22 CAL, .380 CAL / 9MM  
.40 CAL, .45 CAL

## SHOTGUN

20 GA, 12 GA

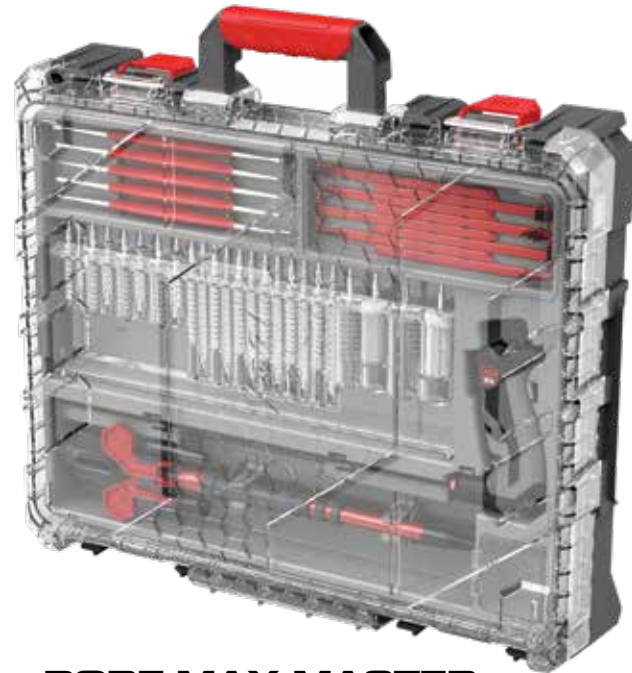

**BORE-MAX MASTER  
CLEANING KIT**

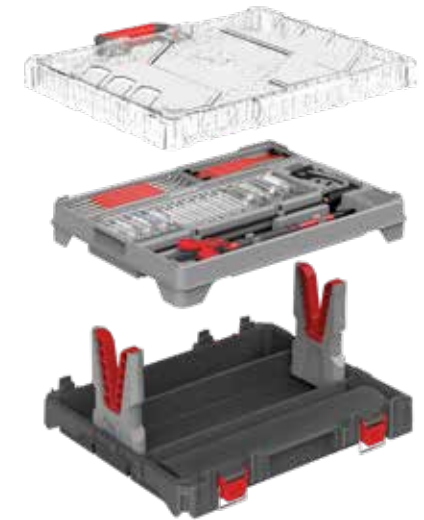

### STACKABLE NESTING

Your workspace is valuable and the Bore-Max Master Cleaning Kit and Mobile Workstation helps to maximize this. The base, components tray and lid can be stacked in a variety of ways to free up space during deployment and still access what you need.



MOBILE WORKSTATION  
FOR GUNS INCLUDES GUN  
GRIPPER™ YOKES AND  
SMART-ASSIST WORK LIGHT



- MOBILE WORKSTATION WITH GUN GRIPPER YOKES
- BORE-MAX BRUSHES™
- BORE-MAX SPEED JAGS™
- BORE-MAX SPEED JAG PATCHES™
- BORE-MAX 3-PIECE SMART ROD – 42"
- SMART-FIT BORE GUIDE
- ACCU-GRIP STEEL PICKS
- SMART BRUSH CLEANING BRUSHES
- GUN & PARTS CLEANING MAT
- SMART-ASSIST WORK LIGHT
- INTEGRATED SMART DOCKS

COMPATIBLE WITH

**SMART  
ASSIST**  
ACCESSORIES



180 LUMEN  
WORK LIGHT

5-INCH MAGNIFYING  
GLASS

CELL PHONE  
HOLDER

(5-INCH MAGNIFYING GLASS AND CELL PHONE  
HOLDER NOT INCLUDED - SOLD SEPARATELY)

## BORE-MAX® MASTER CLEANING KIT AND MOBILE WORKSTATION

The Bore-Max Master Cleaning Kit and Mobile Workstation combines the most comprehensive set of high performance cleaning tools with an integrated stand that allows you to clean your guns better and faster anywhere. First-of-its-kind spring-loaded Smart-Fit® Bore-Guide™ offers a deep and consistent seal of the chamber. The Bore-Max Speed Clean System™ cleans bores up to 4x faster and pairs with our new Bore-Max 3-Piece Speed Rod with ultra-glide bearing. Also includes Accu-Grip™ Steel Picks, Smart Brush® Cleaning Brushes and a cleaning mat. This kit provides the most effective way to clean any firearm. All housed in the innovative Mobile Workstation. The workstation is designed to let you clean your gun anywhere. The built-in yokes firmly grip barrels, handguards and stocks. And the four Smart-Assist™ docks allow you to add a work light (included), magnifying glass or cell phone holder.

ITEM # AVBMMK

# THE FIRST EVER TRUE GUN WORKSTATION.

REVOLUTIONIZE HOW YOU CLEAN, REPAIR, CUSTOMIZE & MOUNT.



THE PERFECT FIT FOR YOUR RIFLES AND SHOTGUNS.

# THE SMART AND EASY WAY TO WORK ON YOUR GUN.

## GUN GRIPPER™

FORM-FITTING RETENTION FOR TIGHT GRIP ON GUN BARRELS



GUN GRIPPER TECHNOLOGY INCORPORATED INTO THE YOKE WRAPS AROUND DIFFERENT CONTOURED BARRELS AND HANDGUARDS PROVIDING EASY ONE-HANDED SECUREMENT.



TRIGGER CLAMP QUICKLY ENGAGES AND DISENGAGES FORM-FITTING FOAM PADS WITH EASE, TO SECURE YOUR FIREARM FOR THE UTMOST PROTECTION.



WHEN INSTALLING OPTICS, THE ACCU-LEVEL™ KNOB LOCATED ON THE TRIGGER CLAMP OFFERS 6 DEGREES OF TILTING MICRO-ADJUSTMENTS FOR LEVELING FIREARMS.



HEIGHT-ADJUSTABLE, NON-SLIP FEET THAT ARE CAPABLE OF BEING CLAMPED TO A BENCH OR BOLTED DOWN FOR A LONG-TERM SOLUTION.

**PATENT**  
realavid.com/pat

## MASTER GUN WORKSTATION®

The Master Gun Workstation is the most advanced, versatile and comprehensive firearm workstation available! Cleaning, scope mounting and light gunsmithing have never had it this easy. The ingenious one-handed setup for firearms with chemical, brushes, jags and cleaning rod storage turned what some would call the ultimate vise into the ultimate workstation.

ITEM # AVMGWS

COMPATIBLE WITH  
**SMART ASSIST**  
ACCESSORIES



180 LUMEN WORK LIGHT



5-INCH MAGNIFYING GLASS



CELL PHONE HOLDER

(ACCESSORIES NOT INCLUDED - SOLD SEPARATELY)

**NEW**

# CLEAN GUNS FASTER. PROTECT GUNS LONGER.



# DELIVERS UNMATCHED PROTECTION, CLEANING AND LUBRICATION FOR PEAK FIREARM PERFORMANCE.

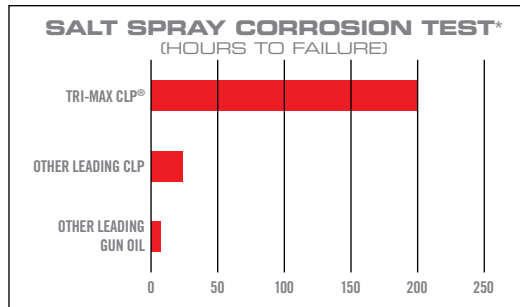

\* Based on internal testing.

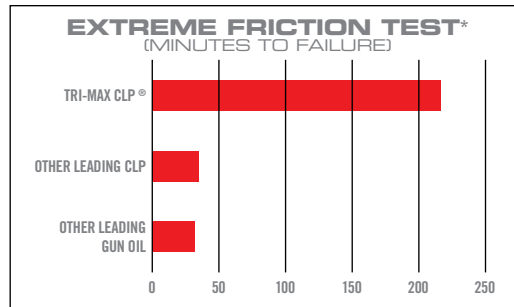

\* Based on internal testing.

POWERFUL INHIBITORS DISPLACE  
MOISTURE, DELIVERING EXTENDED  
CORROSION PROTECTION.

ADVANCED ANTI-FRICTION ADDITIVES BOND  
TO METAL SURFACES FOR LONGER-LASTING  
LUBRICATION OF MOVING METAL PARTS.

## MAXIMUM PERFORMANCE GUN CARE

Real Avid's Maximum Performance Gun Care line, the ultimate solution for shooters, hunters and home protection enthusiasts alike. Our cutting-edge chemicals are designed to deliver unmatched performance, ensuring your firearms operate at their peak.



# ULTIMATE CARE. PEAK PERFORMANCE.

## ADVANCED TRIPLE-ACTION PERFORMANCE

### TRI-MAX CLP®

Tri-Max CLP is a chemically-advanced triple threat to the most common enemies of gun performance – friction, corrosion & gunk. Advanced anti-friction additives bond to metal surfaces for longer lasting lubrication of moving gun parts, also creating a protective barrier against gunk, grime and burnt powder for easier cleaning of the action.

TRI-MAX CLP	12 OZ AEROSOL	ITEM # AVCLP12A
TRI-MAX CLP	4 OZ BOTTLE	ITEM # AVCLP4L
TRI-MAX CLP	60 COUNT CANISTER	ITEM # AVCLPW-C60

## EXTREME CORROSION PROTECTION & LUBRICATION

### GUN-MAX® GUN OIL

Gun-Max's advanced gun-metal grade formula sets a new standard for protecting, lubricating and cleaning modern guns. Maximizes performance of semi-auto guns with high cycle rates. Formulated to excel in sub-zero temperatures and harsh operating conditions.

NEW GUN-MAX GUN GREASE	0.4 FL OZ TUBE	ITEM # AVGMG
GUN-MAX GUN OIL	12 OZ AEROSOL	ITEM # AVMLP12A
GUN-MAX GUN OIL	4 OZ BOTTLE	ITEM # AVBMGO4L
GUN-MAX GUN OIL	1 OZ BOTTLE	ITEM # AVGMGO1L
GUN-MAX WIPES SINGLES	25 PACK	ITEM # AVGMW25

## POWERFUL COPPER & CARBON ELIMINATOR

### BORE-MAX® BORE FOAM AND SOLVENT

Powerful gun-metal grade solvent is specially formulated to expand and penetrate within the gun bore, rapidly and effectively dissolving performance inhibiting copper and powder fouling.

BORE-MAX BORE FOAM	12 OZ AEROSOL	ITEM # AVFBC12A
BORE-MAX BORE SOLVENT	4 OZ BOTTLE	ITEM # AVBMS4L

## WICKED FAST GUN ACTION CLEANER & DEGREASER

### FOUL-OUT® GUNK BLASTER

Foul-Out Gunk Blaster blows away grease and grime fast and leaves no sticky residue. Quickly cleans chambers, actions, trigger groups, bolt groups, slides, choke tube threading, semi-auto gas ports, extractors, ejectors and other hard-to-reach areas.

FOUL-OUT GUNK BLASTER	12 OZ AEROSOL	ITEM # AVDCB12A
-----------------------	---------------	-----------------

# WORLD'S FASTEST BORE CLEANING SYSTEM.

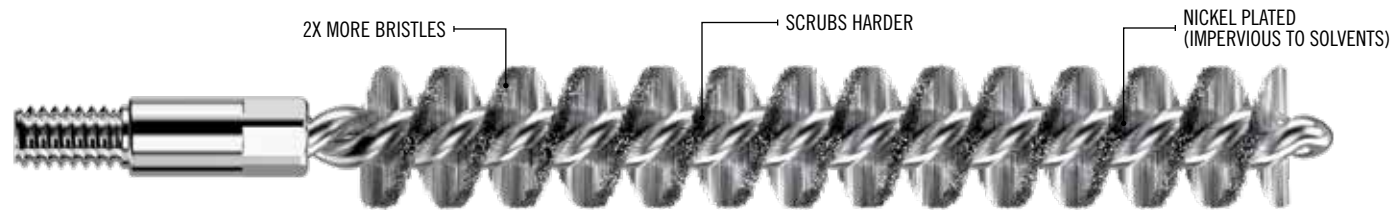

**BORE-MAX® SPEED BRUSHES™**

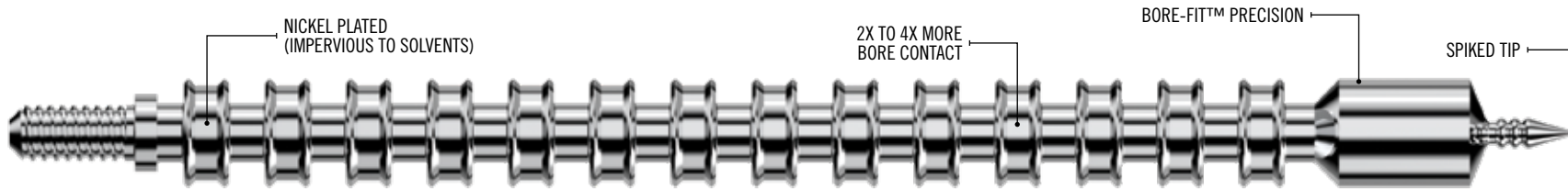

**BORE-MAX SPEED JAG™**

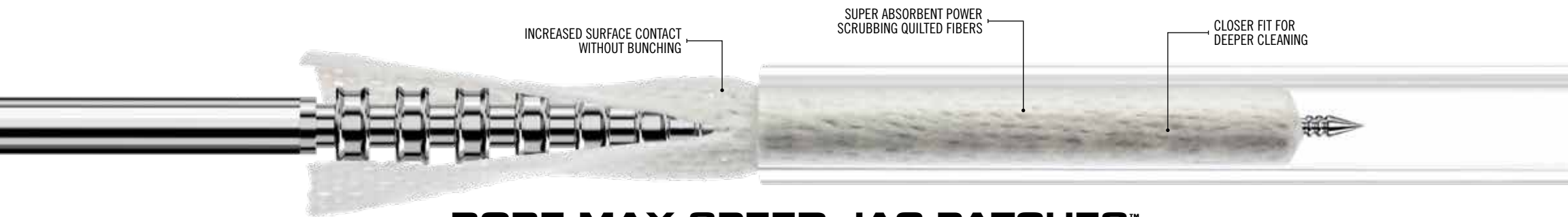

**BORE-MAX SPEED JAG PATCHES™**  
(SHOWN WITH SPEED JAG)

*8" RIFLE SPEED JAG PATCH CENTER SPIKED OVER THE SPEED JAG  
DELIVERS 4" OF CONTINUOUS BORE CONTACT*

# THE BORE-MAX® SPEED CLEAN SYSTEM™ IS PRECISELY SIZED FOR MAXIMUM BORE CONTACT.

The Bore-Max Speed Jag™ & Patches Multi-Cal Pack and Bore-Max Speed Brush® Multi-Cal Pack includes 10 popular pistol and rifle calibers in one convenient storage case.

INCLUDES SET OF 10 JAGS:  
**RIFLE**  
 .22 / .223 CAL / 5.56MM  
 .243 CAL / 6MM  
 .260 CAL / 6.5MM  
 .270 CAL, .284 CAL / 7MM  
 .30 CAL / 7.62MM  
**HANDGUN**  
 .22 CAL, .380 CAL / 9MM  
 .40 CAL, .45 CAL



BORE-MAX SPEED JAG & PATCHES MULTI-CAL PACK  
 ITEM # AVBMJAGS

INCLUDES SET OF 10 BRUSHES:  
**RIFLE**  
 .22 / .223 CAL / 5.56MM  
 .243 CAL / 6MM  
 .260 CAL / 6.5MM  
 .270 CAL, .284 CAL / 7MM  
 .30 CAL / 7.62MM  
**HANDGUN**  
 .22 CAL, .380 CAL / 9MM  
 .40 CAL, .45 CAL



BORE-MAX SPEED BRUSH MULTI-CAL PACK  
 ITEM # AVBMSBS

## REVOLUTIONARY BORE CLEANING SYSTEM.



Maximizing bore contact yields better results. Bore cleaning is a chore, and so the goal is simple – get it done faster and get it done right. The Bore-Max Speed Clean System delivers up to 4 times more bore cleaning contact per pass than traditional brushes, jags and patches. This means less passes to clean your bore and less time spent on the chore. Upgrade to High Performance Gun Care!

### BORE-MAX SPEED BRUSHES™

Twice the bristle density of standard brushes for maximum scrubbing power. Stiff, nickel-plated phosphor bronze bristles eliminate chemical breakdown in the bore and extend the life of the brush.

### BORE-MAX SPEED JAGS™ & PATCHES

Speed Jag and Speed Jag Patches are sized exactly to work in tandem delivering precise bore fitment by caliber, resulting in the removal of up to 4 times the copper and carbon of shorter traditional jags and square patches. This means a cleaner bore with less pass throughs.

### BORE-MAX SPEED CLEAN SYSTEM

INCLUDES SPEED BRUSH, JAG AND PATCHES

An all-in-one upgrade system for faster and easier bore cleaning. System includes the Bore-Max Speed Brush with twice the bristle density of traditional brushes, making it twice as effective in agitating the surface in preparation for the jag and patch. Finish off with the Speed Jag and Patch combination to remove up to 4 times the carbon and copper of shorter traditional jags and square patches.

### BORE-MAX SPEED JAG PATCHES™ REFILL

Speed Jag Patches are specifically designed to provide no-bunch scrubbing when used with corresponding caliber specific Speed Jags. The micro-pore fibers provide maximum absorbency and grit-grabbing surface texture without fraying or dropping lint.

### BORE-MAX SPEED BRUSHES

- |                         |                   |
|-------------------------|-------------------|
| .22 / .223 CAL / 5.56MM | ITEM # AVBMSB223  |
| .243 CAL / 6MM          | ITEM # AVBMSB243  |
| .260 CAL / 6.5MM        | ITEM # AVBMSB65MM |
| .270 CAL                | ITEM # AVBMSB270  |
| .284 CAL / 7MM          | ITEM # AVBMSB7MM  |
| .30 CAL / 7.62MM        | ITEM # AVBMSB30   |
| .338 CAL                | ITEM # AVBMSB338  |
| .35 CAL                 | ITEM # AVBMSB35   |
| .375 CAL                | ITEM # AVBMSB375  |
| .22 CAL                 | ITEM # AVBMSB22   |
| .380 CAL / 9MM          | ITEM # AVBMSB9MM  |
| .40 CAL                 | ITEM # AVBMSB40   |
| .45 CAL                 | ITEM # AVBMSB45   |
| 12 GA                   | ITEM # AVBMSB12G  |
| 20 GA                   | ITEM # AVBMSB20G  |

### BORE-MAX SPEED JAG & PATCHES

- |                         |                    |
|-------------------------|--------------------|
| .22 / .223 CAL / 5.56MM | ITEM # AVBMJAG223  |
| .243 CAL / 6MM          | ITEM # AVBMJAG243  |
| .260 CAL / 6.5MM        | ITEM # AVBMJAG65MM |
| .270 CAL                | ITEM # AVBMJAG270  |
| .284 CAL / 7MM          | ITEM # AVBMJAG7MM  |
| .30 CAL / 7.62MM        | ITEM # AVBMJAG30   |
| .22 CAL                 | ITEM # AVBMJAG22   |
| .380 CAL / 9MM          | ITEM # AVBMJAG9MM  |
| .40 CAL                 | ITEM # AVBMJAG40   |
| .45 CAL                 | ITEM # AVBMJAG45   |

### BORE-MAX SPEED CLEAN SYSTEM

INCLUDES SPEED BRUSH, JAG AND PATCHES

- |                         |                    |
|-------------------------|--------------------|
| .22 / .223 CAL / 5.56MM | ITEM # AVBMSET223  |
| .243 CAL / 6MM          | ITEM # AVBMSET243  |
| .260 CAL / 6.5MM        | ITEM # AVBMSET65MM |
| .270 CAL                | ITEM # AVBMSET270  |
| .30 CAL / 7.62MM        | ITEM # AVBMSET30   |
| .380 CAL / 9MM          | ITEM # AVBMSET9MM  |
| .40 CAL                 | ITEM # AVBMSET40   |
| .45 CAL                 | ITEM # AVBMSET45   |

### BORE-MAX SPEED JAG PATCHES REFILL

- |                       |                    |
|-----------------------|--------------------|
| RIFLE                 | ITEM # AVBMPATCH8  |
| HANDGUN .32 - .45 CAL | ITEM # AVBMPATCH4L |
| HANDGUN .22 CAL       | ITEM # AVBMPATCH4S |

## MAXIMUM BORE CLEANING.

# THE PORTABLE, SECURE GUN CLEANING AND MODIFICATION STAND.



ADJUSTABLE 10" – 16" FOOTPRINT

## GUN GRIPPER TECHNOLOGY.

Flexible support allows for the right amount of friction and retention when working on your firearms.



**GUN GRIPPER™**  
FORM-FITTING RETENTION FOR FIREARMS.

THE PORTABLE, SECURE GUN CLEANING AND MODIFICATION STAND.

**PATENT**  
realavid.com/pat

## SPEED STAND™

The Speed Stand is the most portable and convenient gun cleaning stand on the market. Use at home or at the range for quick modifications and cleaning on all your rifles and shotguns. The adjustable feet allow for use on uneven surfaces while the Gun Gripper yokes firmly secure your firearm.

ITEM # AVSSFG

# SPRING-LOADED DESIGN ALLOWS FOR A CONSISTENT CHAMBER SEALING.

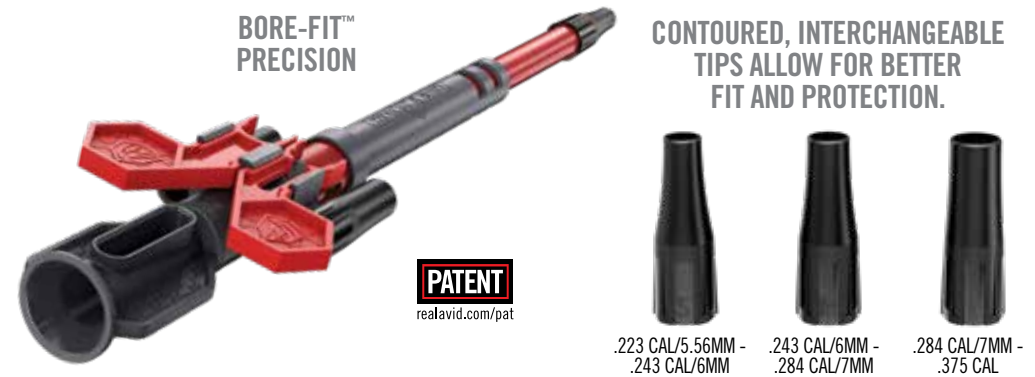

BORE-FIT™ PRECISION

CONTOURED, INTERCHANGEABLE TIPS ALLOW FOR BETTER FIT AND PROTECTION.

**PATENT**  
realavid.com/pat

.223 CAL/5.56MM - .243 CAL/6MM

.243 CAL/6MM - .284 CAL/7MM

.284 CAL/7MM - .375 CAL

## SMART-FIT® BORE GUIDE™

The Smart-Fit Bore Guide is the ultimate and first-of-its-kind spring-loaded, precision cleaning tool, providing worry-free cleaning. The spring-loaded slider locks, providing a secure fitment and ensures a consistent chamber sealing with zero movement when running brushes and patches through your bore. An anodized aluminum tube is designed for lasting durability and the contoured, non-marring, bore-specific tips ensure damage-free, precise fitment on centerfire rifles from .223 - .375 caliber.

ITEM # AVBMBG

ULTRA-GLIDE BEARINGS DELIVER SILKY-SMOOTH ROTATION TO EFFECTIVELY CLEAN LANDS & GROOVES.

**PATENT**  
realavid.com/pat



## BORE-MAX® SMART ROD®

Upgraded comfort grip made for pushing and pulling jags, patches and brushes through the bore. Easier on your wrist and hands due to the vertical grip versus old-school horizontal screwdriver grips. The carbon fiber rod easily turns through the bore following the rifling thanks to the ultra-glide bearing handle attachment.

.22 - .270 CAL 36" CARBON FIBER  
.270 - .45 CAL 36" CARBON FIBER  
.270 - .45 CAL 44" CARBON FIBER  
.22 - .45 CAL 9" CARBON FIBER

ITEM # AVBMSR2236  
ITEM # AVBMSR3036  
ITEM # AVBMSR3044  
ITEM # AVBMSR2209

# THE ULTIMATE WAY TO CLEAN AND MAINTAIN AR15s.

**BOLT CARRIER GROUP  
CARBON REMOVAL  
MULTI-TOOL**

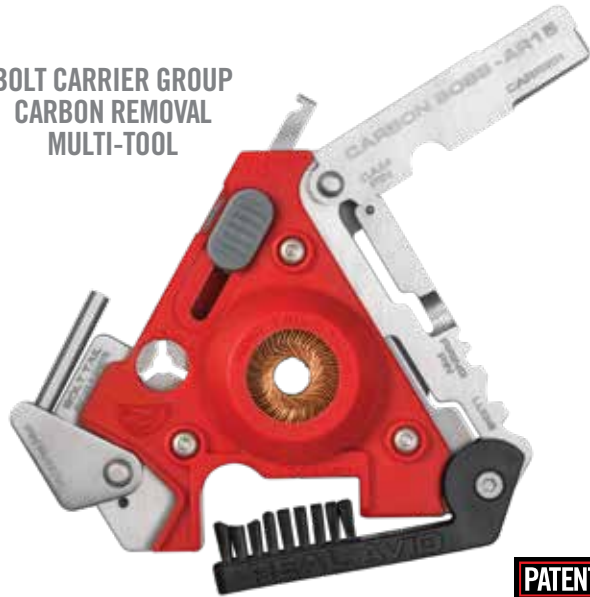

**PATENT**  
realavid.com/pat

**NEXT-GEN  
CARBON SUPER  
TOOL FOR BCG'S**



**BALLISTIC  
NYLON SHEATH**

## **CARBON BOSS® - AR15**

Smartly designed, this is the most comprehensive carbon removal multi-tool ever. Packed with easy-to-use precision cleaning tools.

ITEM # AVCARBAR15



**PRECISION CLEANING  
TOOL FOR BCG'S**

## **THE AR15 SCRAPER™**

A dirty bolt carrier group (BCG) is the #1 cause of AR15 malfunctions. Carbon is the enemy and it quickly builds up in hard-to-clean areas.

ITEM # AVAR15S



AR15 PIVOT  
LOCK



STAR CHAMBER BRUSH



SCRAPER PRECISELY FITS  
BARREL EXTENSION AND  
INTERNAL CHAMBER



5 WOOL STAR CHAMBER CLEANING PADS

## **ALL-IN-1 CHAMBER CLEANING KIT**

### **CHAMBER BOSS® - AR15**

Every tool you need to easily eliminate baked-on carbon from the AR15 chamber. All cleaning implements store inside the ergonomic handle.

ITEM # AVAR15CB



ALL COMPONENTS WORK WITH  
STANDARD 8-32 THREADS

**.223 CAL / 5.56MM CHAMBER  
AND BORE CLEANING.**

### **AR15 BRUSH COMBO™**

The AR15 Brush Combo contains the critical components you need to keep your AR15 chamber and bore carbon free.

ITEM # AVAR15BC

### **AR15 STAR CHAMBER CLEANING PADS**

Use a star chamber brush to loosen the carbon then remove it with our star chamber cleaning pads (20 count pack) and a healthy dose of solvent.

ITEM # AVAR15CP

PREMIUM .223 CAL / 5.56MM  
STAR CHAMBER  
CLEANING PADS



# FIRST-EVER SELF-STORING, ALL-IN-ONE GUN CLEANING STATIONS.

ADVANCED CLEANING KIT,  
DELUXE GUN MAT, ALL-IN-ONE.

## MASTER CLEANING STATION®

The world's first Master Cleaning Stations. Designed to empower gun owners to thoroughly clean guns from bore, breech and action down to the component level. The case provides frustration-free, spill-proof storage and features a proprietary pop-up storage riser making every tool easy to extract and return to its fitted holder. A magnetic parts tray keeps small gun parts from getting lost during cleaning. Finally, an integrated, oil-resistant, non-slip backed, padded cleaning mat provides a large, safe, anywhere-anytime cleaning surface. The entire expansive Master Cleaning Station rolls up and fits into a compact storage bag.

MASTER CLEANING STATION - UNIVERSAL GUN  
MASTER CLEANING STATION - AR15  
MASTER CLEANING STATION - HANDGUN

ITEM # AVMCS-U  
ITEM # AVMCS-AR  
ITEM # AVMCS-P

ATTACHED SPILL-PROOF, IMPACT-RESISTANT CASE COMES EQUIPPED WITH A COMPREHENSIVE SET OF CLEANING TOOLS

## UNIVERSAL GUN



## AR15



## HANDGUN



ERGONOMIC HANDLE  
ROTATES, TAPS PINS  
AND ALSO WORKS  
AS A DETAILING HANDLE

**PATENT**  
realavid.com/pat

# PROFESSIONAL-GRADE KITS. NOT TYPICAL, CHEAP, TRAY-BASED, SPILL-PRONE KITS.

**PATENT**  
realavid.com/pat



**UNIVERSAL**



**AR15**



**HANDGUN**



**PRECISION**

## GUN BOSS® PRO

Gun Boss Pro is the answer to cheap, flimsy, spill-prone cleaning kits. The virtually indestructible, stand-up case puts a complete set of gun cleaning tools at your fingertips. Premium components are secured into labeled, fitted tool slots and stay organized. No annoying loose parts. Conveniently the lid doubles as a kick-stand, standing the case up for easy access to tools.

GUN BOSS PRO - UNIVERSAL CLEANING KIT  
GUN BOSS PRO - AR15 CLEANING KIT  
GUN BOSS PRO - HANDGUN CLEANING KIT  
GUN BOSS PRO - PRECISION CLEANING TOOLS

ITEM # AVGBPRO-U  
ITEM # AVGBPROAR15  
ITEM # AVGBPRO-P  
ITEM # AVGBPROPCT



## GUN BOSS PRO - AR15 MAX

The virtually indestructible stand-up case puts a complete Gun Boss Pro - AR15 plus AR15 Scrapper™ kit at your fingertips. Tools snap securely into place and stay organized — unlike the chaos of conventional kits. Professional, specialized and smart. It's a superior experience for modern shooters.

ITEM # AVGBPROARS

**NEW**

# HOME & FIELD DOUBLE-DUTY, PROFESSIONAL GUN CLEANING KITS.

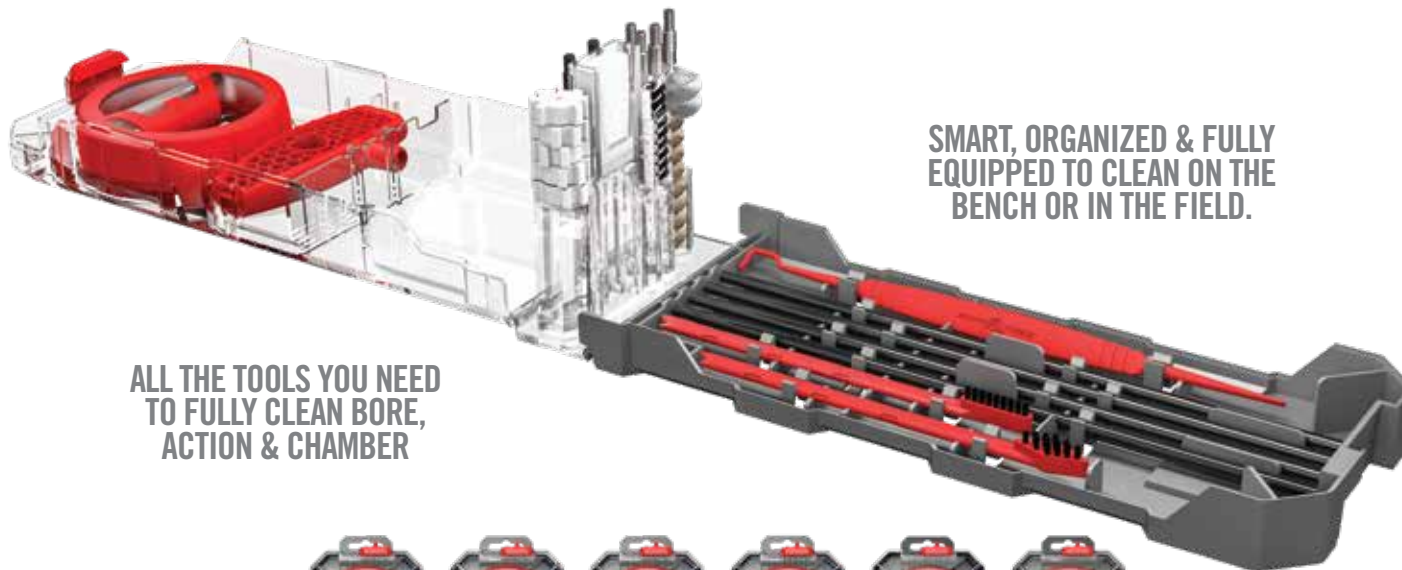

SMART, ORGANIZED & FULLY EQUIPPED TO CLEAN ON THE BENCH OR IN THE FIELD.

ALL THE TOOLS YOU NEED TO FULLY CLEAN BORE, ACTION & CHAMBER



## GUN BOSS® MULTI-KIT

Home and field double-duty, single-caliber, specialized gun cleaning kits. Kits include the Bore Boss® for a quick clean any time you shoot your gun, and an expanded gun cleaning kit with all the tools you need to fully clean the bore, action and chamber.

.22 CAL  
.223 CAL / 5.56MM  
.270 / .280 CAL / 7MM  
.30 / .308 CAL / 7.62MM  
.357 / .38 CAL / 9MM

RIFLE  
RIFLE  
RIFLE  
RIFLE  
RIFLE  
HANDGUN

ITEM # AVGBMK22  
ITEM # AVGBMK223  
ITEM # AVGBMK243  
ITEM # AVGBMK270  
ITEM # AVGBMK308  
ITEM # AVGBMK9MM

**PATENT**  
realavid.com/pat

COMPLETE TACTICAL CLEANING KIT IN A MODERN TOOL CASE.



BUTTERFLY-STYLE CASE LAYS FLAT WHEN OPEN

EVERY COMPONENT STAYS LOCKED IN PLACE

## READY, LOCKED AND ORGANIZED.

### PRIME-223 & PRIME-9

These Next-Gen Cleaning Kits go beyond basic bore cleaning. Packed in a modern butterfly case that opens flat, every tool stays secure and accessible with no loose parts. Caliber-specific brushes, a bore mop, precision tools, and patch dispenser make cleaning fast, efficient and complete.

**NEW** .223 CAL / 5.56MM  
.357 / .38 CAL / 9MM

ITEM # AVGCK223  
ITEM # AVGCK9MM

# WORLD'S EASIEST BORE CLEANER IS NOW THE FASTEST SELLER.



**PATENT**  
realavid.com/pat

12 CHOICES - .17 CAL TO 12 GA

## BORE BOSS®

The single-piece Dual-Action Cable with integrated phosphor bronze brush and braided mop wraps around the unique Flex-Case Handle to keep the system stowed and organized. To use, simply flip, feed, clip and pull. Throw it in your pack, or put it in your pocket. It's the next best thing to a self-cleaning gun.

.17 CAL  
.22 CAL  
.223 CAL / 5.56MM  
.243 / .260 CAL / 6.5MM  
.270 / .280 CAL / 7MM  
.30 / .308 CAL / 7.62MM  
9MM CARBINE  
.357 / .38 CAL / 9MM  
.40 / .41 CAL  
.44 / .45 CAL  
20 GA  
12 GA (NEW LONGER SIZE)

RIFLE  
RIFLE  
RIFLE  
RIFLE  
RIFLE  
RIFLE  
RIFLE  
CARBINE  
HANDGUN  
HANDGUN  
HANDGUN  
SHOTGUN  
SHOTGUN

ITEM # AVBB17  
ITEM # AVBB22  
ITEM # AVBB223  
ITEM # AVBB243  
ITEM # AVBB270  
ITEM # AVBB308  
ITEM # AVBB9MM-CAR  
ITEM # AVBB9MM  
ITEM # AVBB40  
ITEM # AVBB45  
ITEM # AVBB20G  
ITEM # AVBB12G

## RUGGED & READY TACTICAL CLEANING KITS.

AR15 KIT FITS  
.223 CAL / 5.56MM

20-PIECE AR15  
CLEANING KIT

### GUN BOSS® - AR15

Extremely compact so it can be carried anywhere. It contains everything needed to preserve the accuracy and reliability of an AR15. A chamber brush, carbon picks and star chamber pads help to clean more than the bore and keep your bolt cycling smoothly. Smartly organized, each brush, pick, jag, patch, pad and rod is held securely in place.

ITEM # AVGCKAR15



14-PIECE SHOTGUN  
CLEANING KIT

SHOTGUN KIT FITS  
20 & 12 GA

### GUN BOSS - SHOTGUN

Big functionality in a small rugged package that easily fits into a pack or range bag. A complete cleaning kit designed to keep your shotgun tip-top in the field. No annoying loose parts. Smartly organized, each brush, mop and slotted patch tip is held securely in place. The Gun Boss Shotgun Cleaning Kit is a complete cleaning system that easily travels with you.

ITEM # AVGCK310-S



HANDGUN KIT FITS  
.22 - .45 CAL

13-PIECE HANDGUN  
CLEANING KIT

### GUN BOSS - HANDGUN

A complete system to keep your handgun clean and firing accurately. Aluminum connectors, nylon jags, slotted tips and phosphor bronze brushes protect bores. Take it anywhere, exclusively for handguns the Gun Boss Handgun Cleaning Kit moves easily between the field, range and workbench.

ITEM # AVGCK310-P



HANDS-FREE  
ILLUMINATION

### MAGNETIC BORE LIGHT™

Magnetic bore light clings to your firearm's steel surfaces for quick and easy inspection into your bore, chamber or action.

ITEM # AVBR101-B



TABLE GRIPPING, OIL REPELLING, SHOCK ABSORBING, PARTS SECURING, GUN CLEANING AWESOMENESS.



**PATENT**  
realavid.com/pat

LONG GUN MATS 43" X 16"  
HANDGUN MATS 19" X 16"

## NEXT-GEN CLEANING MATS WITH INTEGRATED PARTS TRAY.

### SMART MAT® CLEANING MATS

These are cleaning mats on steroids. The no-slip backed padded mat features an oil-resistant surface, allowing you to properly clean your gun without ruining the kitchen table and is large enough to handle field-stripped guns. The ingenious magnetic parts tray ensures your pins, screws and springs are never lost again.

SMART MAT - AR15  
SMART MAT - UNIVERSAL  
SMART MAT - GLOCK\*  
SMART MAT - HANDGUN

ITEM # AVAR15SM  
ITEM # AVULGSM  
ITEM # AVGLOCKSM  
ITEM # AVUHGSM

### AR15



### UNIVERSAL



### GLOCK



### HANDGUN



\*DISCLAIMER: This product is not manufactured, authorized, endorsed, or warranted by GLOCK. GLOCK does not warrant or represent that this product is compatible with GLOCK pistols. "GLOCK" is a federally registered trademark of GLOCK, Inc. and is one of many trademarks owned by GLOCK, Inc. and GLOCK Ges.m.b.H. New Revo Brand Group, LLC, d/b/a Real Avid is not affiliated in any manner with, or otherwise endorsed by, GLOCK, Inc. or GLOCK Ges.m.b.H.

# ERGONOMIC GUN DETAILING TOOLS.



## ACCU-GRIP™ STEEL PICKS

Firearm owners have had no choice but to use subpar cleaning picks for years. Accu-Grip Steel Picks offer specifically designed tips ensuring easy work on carbon build-up. The ergonomic design and stainless steel picks fit comfortably in your hand.

ITEM # AVAGSPS

## ERGONOMIC GUN DETAILING TOOLS

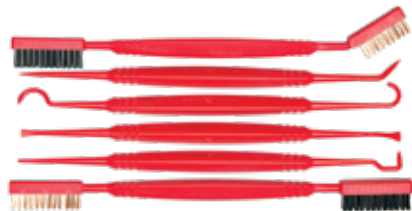

## ACCU-GRIP PICKS & BRUSHES

We created a superior line of picks and brushes that gives you complete control when cleaning hard-to-reach areas, comfortably fits in your hand and most importantly – won't damage your firearm.

ITEM # AVPBS



## CARBON BUSTING MICRO-BRISTLES

## SMART BRUSH® CLEANING BRUSHES

Our unique brush shapes with integrated scrapers are designed to specifically clean hard-to-reach interior and exterior surfaces where carbon and gunk accumulate.

ITEM # AVSB01

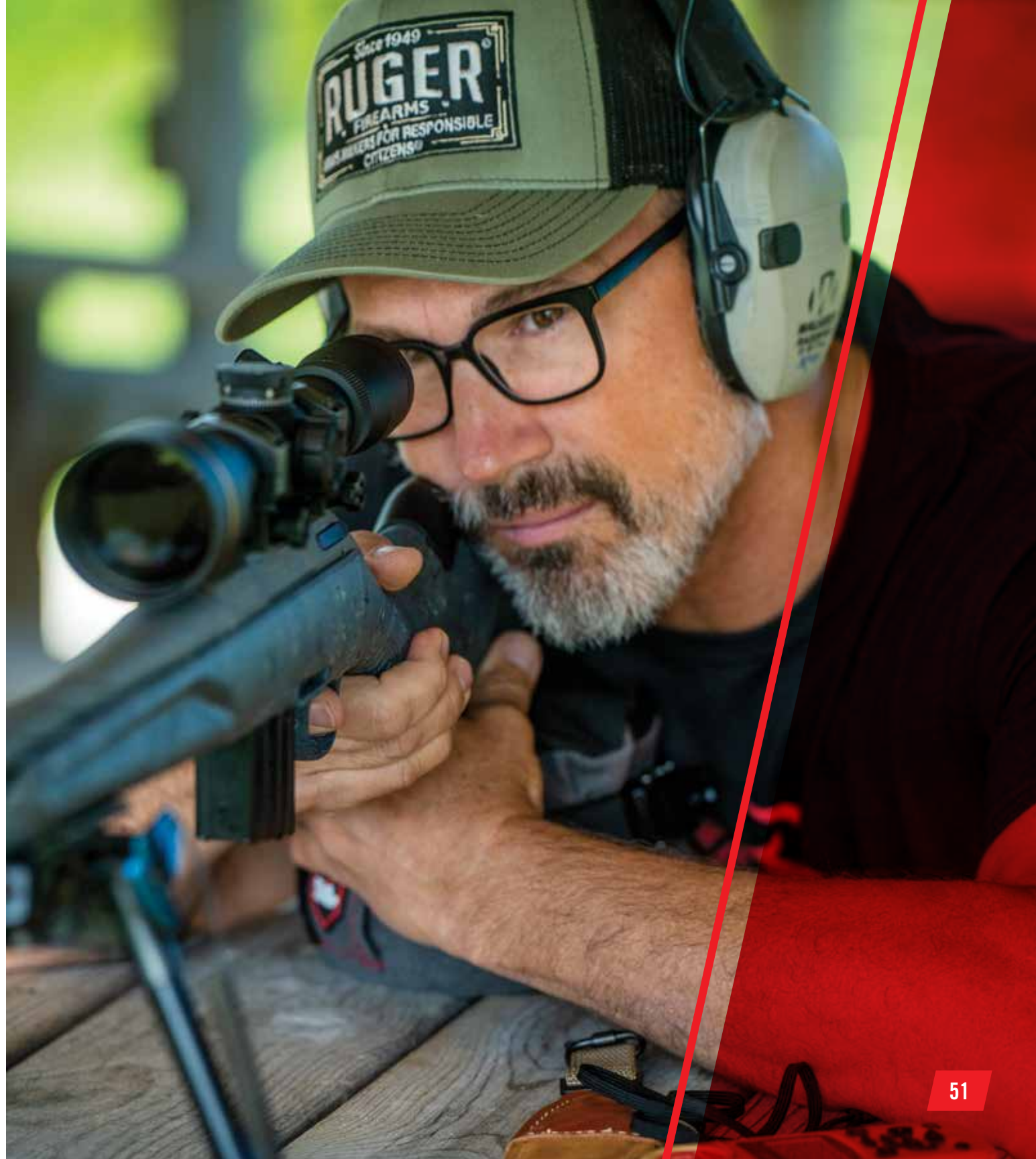

# TOOLS SPECIFICALLY DESIGNED FOR MUZZLELOADERS.

PUSH-BUTTON DEPLOYMENT OF 4 BREECH PLUG-SPECIFIC TOOLS.



ADVANCED MULTI-TOOL FOR MUZZLELOADER BREECH PLUGS

## BREECH PLUG 4-IN-1 SCRAPER™

The Breech Plug 4-in-1 Scraper, the essential all-in-one tool designed to keep your breech plug in peak condition, whether you're at the bench or in the field. This versatile scraper features a push-button mechanism for effortless tool switching, a 1.3" (34mm) long wire for cleaning out carbon build-up inside the flash hole, a dedicated 1.4" (35.5mm) long flash channel scraper and two different fouling scrapers for detailed cleaning of breech plug heads. From routine maintenance to on-the-spot fixes, the Breech Plug 4-in-1 Scraper is your go-to solution for keeping your breech plug up and running when you need it most.



BREECH PLUG 4-IN-1 SCRAPER

DOUBLE-ENDED SPANNER WRENCH



11MM SOCKET



12MM SOCKET



OVAL BREECH SOCKET



SLOTTED BREECH SOCKET



COMPREHENSIVE KIT OF BREECH PLUG TOOLS.



SMART BRUSH® BREECH THREAD BRUSHES



5.5" (140MM) CLEANING ROD EXTENSIONS



2 - 4.7" (120MM) - 1/4" SOCKET EXTENSIONS



BREECH THREAD BRUSH

4.9" (125MM) - 1/4" SOCKET BREAKER BAR WITH 8/32 THREADS FOR CLEANING ROD



## BREECH PLUG MASTER MAINTENANCE KIT™

The next-level Breech Plug Master Maintenance Kit is the first of its kind to streamline upkeep on your modern in-line muzzleloader, especially the crucial breech plug. This all-in-one kit includes essential tools designed to make removing or cleaning breech plugs a breeze across various muzzleloader models. Whether you own a CVA®, Traditions®, Knight® or many other modern in-line muzzleloader brands, this kit simplifies your maintenance routine. Enjoy having everything you need, neatly organized inside a beautifully designed field case, ensuring that your tools are easily accessible and well-protected.

# CRITICAL-TASK CARRY TOOLS.



## GUN TOOL EDGE™

Gun Tool Edge redefines firearm maintenance with precision and durability. The AR15 tactical knife/multi-tool features a 2.6" Tanto blade, titanium and black oxide finishes for superior performance. With 12 functions, it excels in the field. The pistol tactical knife/multi-tool ensures readiness with a 2.6" Wharncliffe blade, hex keys for laser sights and titanium finishes. Stainless steel components guarantee easy access. Both purpose-driven solutions redefine firearm excellence, offering efficiency and precision in maintenance. Upgrade your gear for a new era of performance and versatility.

GUN TOOL EDGE - AR15  
GUN TOOL EDGE - PISTOL

ITEM # AVGTE-AR  
ITEM # AVGTE-P



CARABINER-LIKE FUNCTION SECURES TO MOLLE STRAPS

## GUN TOOL CORE®

Compact and fully capable, the Gun Tool CORE is the ideal tool for performing critical “keep shooting” tasks on your gun. Small and streamlined in stature, but big on solving the most commonly encountered problems, keeping you up and running in the field or at the range. Easy to carry with carabiner-like modularity, CORE easily secures to MOLLE straps or a belt. CORE is a must-have carry tool for serious shooters.

GUN TOOL CORE - SHOTGUN  
GUN TOOL CORE - AR15

ITEM # AVGTCOR-SG  
ITEM # AVGTCOR-AR

**PATENT**  
realavid.com/pat

# THE SMARTEST, MOST CAPABLE MULTI-TOOLS FOR THE WORLD'S MOST POPULAR PLATFORM.

## 37-IN-1 TACTICAL GUN MULTI-TOOL



MOLLE-COMPATIBLE BALLISTIC NYLON SHEATH



### INCLUDES 12 BITS:

- 3/32" ALLEN®    ○ 7/64" ALLEN
- 1/8" ALLEN      ○ 9/64" ALLEN
- 3/16" ALLEN    ★ T10 TORX
- ★ T15 TORX®     ★ T20 TORX
- ⊕ #1 PHILLIPS®    | 3/16" FLAT
- | 3/32" FLAT      | 1/4" FLAT



SQUARE CUT HOLLOW GROUND

A1 & A2 FRONT SIGHT ADJUSTER



**PATENT**

realavid.com/pat

### AR15 TOOL™

This beefy, folding X-frame tool is built specifically for the needs of AR15 owners who want to keep their gun in the fight. It equips users to quickly remove carbon from all 12 critical surfaces of the bolt carrier group, make repairs in the field or on the bench, reduce malfunctions, add or remove accessories, make sight adjustments and easily disassemble and reassemble their guns.



### INCLUDES 9 BITS:

- 3/32" ALLEN®    ○ 7/64" ALLEN
- 1/8" ALLEN      ○ 9/64" ALLEN
- 3/16" ALLEN    ⊕ #1 PHILLIPS®
- | 3/32" FLAT      | 3/16" FLAT
- AR15 PIN PUNCH



SQUARE CUT HOLLOW GROUND

A1 & A2 FRONT SIGHT ADJUSTER



MOLLE-COMPATIBLE BALLISTIC NYLON SHEATH



## 35-IN-1 GUN MULTI-TOOL FOR THE AR15

### GUN TOOL PRO® - AR15

When it comes to keeping your AR15 going bang and getting the most for your buck, Gun Tool Pro - AR15 is the clear choice. Thirty-five highly capable tools in a tactical, rugged design work with ease and precision to keep black guns firing reliably and accurately. From teardown and carbon scraping, to maintenance and reassembly.

# TOOLS SPECIFICALLY DESIGNED FOR POPULAR RIFLE AND SHOTGUN PLATFORMS.

## 37-IN-1 UNIVERSAL GUN MULTI-TOOL

INCLUDES 12 BITS:

- ★ T10 TORX®
- ★ T20 TORX
- ⊕ #1 PHILLIPS®
- ⓪ 3/32" FLAT
- ⓪ 5/32" ALLEN®
- ⓪ 1/8" ALLEN
- ★ T15 TORX
- ⊕ #00 PHILLIPS
- ⊕ #2 PHILLIPS
- ⓪ 3/16" FLAT
- ⓪ 9/64" ALLEN
- ⓪ 3/32" ALLEN



MOLLE-COMPATIBLE BALLISTIC NYLON SHEATH

**PATENT**  
realavid.com/pat

### GUN TOOL MAX®

Packed with precision-made, gun-specific tools for hunters and shooters, this highly-versatile multi-tool repairs, customizes and makes disassembly and reassembly fast and easy. The ballistic nylon sheath carries 12 additional bits for added functionality. It's a whole new breed of Gun Tool.

ITEM # AVGTMAX

INCLUDES 9 BITS:

- ★ T10 TORX®
- ★ T20 TORX
- ⊕ #1 PHILLIPS®
- ⓪ 3/32" FLAT
- ⓪ PIN PUNCH
- ★ T15 TORX
- ⊕ #00 PHILLIPS
- ⊕ #2 PHILLIPS
- ⓪ 3/16" FLAT



## 30-IN-1 GUN MULTI-TOOL FOR RIFLES & SHOTGUNS

### GUN TOOL PRO®

Made for rifles and shotguns, Gun Tool Pro's rock-solid frame features 30 hard-working tools. All in a sleek tactical design. Gun Tool Pro sets the standard for compact gun tools.

ITEM # AVGTPRO



INCLUDES 4 BITS:

- ⊕ #1 PHILLIPS®
- ⊕ #2 PHILLIPS
- ⓪ 1/8" FLAT
- ⓪ 3/16" FLAT

**PATENT**  
realavid.com/pat

## 18-IN-1 SHOOTERS MULTI-TOOL

### THE GUN TOOL™

The Gun Tool is the original shooter's multi-tool. This patented design features 18 of the most frequently used firearm tools. The Gun Tool gives you a lot of capability whether you're in the field, on the range or at your workbench.

ITEM # AVGTCL211

# THE HANDGUN OWNERS' TOOL KIT THAT FITS IN A MAG POUCH.

19-IN-1 GUN MULTI-TOOL FOR HANDGUNS



SQUARE CUT HOLLOW GROUND

6 HEX BITS WITH BALL DETENTS:

- ★ T15 TORX®
- ⊖ 3/32" HEX
- ⊖ 1/8" FLAT
- ⊖ 3/16" FLAT
- ⊕ #1 PHILLIPS®
- ⊕ #2 PHILLIPS



COMPACT SIZE FITS CONVENIENTLY INTO A PISTOL MAG POUCH

4 BONDHUS PROTANIUM® HEX KEYS FOR LASER SIGHTS

- 1/16"
- .05"
- .035"
- .028"



## THE PISTOL TOOL™

The list of possibilities is long and thorough – mounting accessories, field disassembly, adjusting laser sights and changing side grips are just a few. Here, with easy one-hand access, is every tool a shooter could want to service and adjust the handgun of their choosing. Each tool locks open and is carefully calibrated to popular pistol platforms – from a polymer striker fired pistol to everything needed to take down the 1911.

ITEM # AVPSTL



PATENT  
realavid.com/pat

PATENT  
realavid.com/pat



## BARREL BUSHING WRENCH

### SMART WRENCH® - 1911

Finally, a solution to the problem you've been dealing with for years. Removing the barrel bushing on your 1911 has never been easier. Press and turn. The ingenious design keeps the spring and plug corralled – and you out of the dentist's chair.

ITEM # AV1911SW

# NEXT LEVEL A1 & A2 FRONT SIGHT ADJUSTMENT



## FRONT SIGHT ADJUSTER™ PRO

PATENT  
realavid.com/pat

This smartly-designed tool makes front sight adjustments quick, easy and painless. The new longer, black oxide coated steel shaft is paired with an ingenious T-Handle to create the perfect combo when working with both A1 & A2 front sights. The compact carry case makes storing and protecting your tool easier, whether in your range bag or hanging from a lanyard.

ITEM # AVARFSAPRO

FITS BOTH 5-PIN AND 4-PIN FRONT SIGHTS



## AR15 FRONT SIGHT ADJUSTER TOOL

This smartly-designed tool makes front sight adjustments quick and easy. The stainless steel shaft is knurled to create no-slip leverage when turning tight posts.

ITEM # AVAR15FSA

## 18-IN-1 CARRY TOOL

### MICRO TOOL™ - AR15

AR15-specific functionality packed into a micro-sized tool. A multitude of breakdown, carbon scraping, adjusting and sighting-in options are ready at a moments notice. This pint-sized tool is as welcome on your keychain as it is at the range. Always be prepared, no matter the scenario.

ITEM # AVMICROAR15



## FINI™ - UNIVERSAL CHOKE TUBE WRENCH

This pocket-sized tool is the most versatile choke wrench ever. It fits most brands and all gauges between .410 and 10 gauge. It also sports a handy screwdriver blade perfect for adjusting scope turrets or making repairs.

ITEM # AVCWT210



THE ONLY CHOKE TUBE WRENCH YOU WILL EVER NEED

# ESSENTIAL TOOLS FOR GLOCK\* OWNERS.



## PUSH BUTTON ARMORER'S MULTI-TOOL

- 3/16" HEX NUT DRIVER
- .050" ALLEN® WRENCH
- FLAT BLADE SCREWDRIVER
- 3MM ARMORER'S PIN PUNCH

PUSH BUTTON DEPLOYMENT OF 4 GLOCK-SPECIFIC TOOLS.

## 4-IN-1 TOOL™ FOR GLOCK\*

Sleek, ergonomic, packed with function. In every way a thoroughly modern armorer's tool for Glock owners. Four different tools store inside the handle and each snaps open and locks in place with the push of a button. Remove pins for disassembly, change out front sights, remove slide lock spring and locking block and adjust aftermarket rear sights.

ITEM # AVGLOCK41

## ARMORER'S COMBINATION DISASSEMBLY & FRONT SIGHT TOOL



THE GLOCK OWNER'S ESSENTIAL TOOL. FITS ALL MODELS.

- 3/16" HEX NUT DRIVER
- 3MM ARMORER'S PIN PUNCH

## 2-IN-1 TOOL™ FOR GLOCK\*

This is the essential armorer's tool for Glock owners. Precisely-machined steel matches the quality of your gun. It combines the ability to completely disassemble your gun for cleaning and maintenance with the ability to change front sights.

ITEM # AVGLOCK21

## MAGAZINE QUICK-DISASSEMBLY TOOL

CHANGE BASE PLATES OR DISASSEMBLE GLOCK MAGAZINES FOR SAFE AND EASY CLEANING.



MAGAZINE UNLOADER



**PATENT**  
realavid.com/pat

## SMART MAG TOOL™ FOR GLOCK\*

Change base plates or disassemble Glock magazines for safe and easy cleaning. No fumbling, no need for an extra hand, no out-of-control springs launching across the room. The Smart Mag Tool for Glock simplifies the process by allowing you to break open the baseplate, and slide it off while retaining the spring in a secure position.

ITEM # AVGLOCKMT

## NEXT-GEN CLEANING MAT WITH INTEGRATED PARTS TRAY



**PATENT**  
realavid.com/pat

## SMART MAT® FOR GLOCK\*

This mat was built by people who know guns inside and out and were fed up with the old way of doing things. It is the perfect size to handle a fieldstripped Glock with the visible instructions to help you break it down. The attached parts tray ensures your pins and springs are never lost again.

ITEM # AVGLOCKSM

\*DISCLAIMER: This product is not manufactured, authorized, endorsed, or warranted by GLOCK. GLOCK does not warrant or represent that this product is compatible with GLOCK pistols. "GLOCK" is a federally registered trademark of GLOCK, Inc. and is one of many trademarks owned by GLOCK, Inc. and GLOCK Ges.m.b.H. New Revo Brand Group, LLC, d/b/a Real Avid is not affiliated in any manner with, or otherwise endorsed by, GLOCK, Inc. or GLOCK Ges.m.b.H.





# UNWAVERING COMMITMENT.

At Real Avid, we know that everyone has missions in life, some we choose and some we're given. Success often depends on having the right partner by your side. Our mission is to be that partner for you, delivering smarter, easier and more effective ways to care for, customize and enjoy your firearms. We design tools and gear that make a real difference, so you can focus on what matters most. Confidence, readiness and the enjoyment of shooting.

For the owners of Real Avid, our partner in all of our missions is Jesus Christ. Everything that we do is gently governed by our faith in who He is and how He has changed our lives. It guides our business practices, fuels our creativity and drives us to do everything that we can to honor Him. He leads us to serve others with love and grace and to show by example what real faith looks like in a hurting world. We hope that ultimately, He becomes your partner in your life's mission.

*John 3:16 "For God so loved the world that He gave his one and only son, that whoever believes in Him will not perish but have eternal life."*





**\*DISCLAIMER:** The products in this catalog are not manufactured, authorized, endorsed, or warranted by GLOCK. GLOCK does not warrant or represent that this product is compatible with GLOCK pistols. "GLOCK" is a federally registered trademark of GLOCK, Inc. and is one of many trademarks owned by GLOCK, Inc. and GLOCK Ges.m.b.H. New Revo Brand Group, LLC, d/b/a Real Avid is not affiliated in any manner with, or otherwise endorsed by, GLOCK, Inc. or GLOCK Ges.m.b.H.

**\*\*DISCLAIMER:** The products in this catalog are not manufactured, authorized, endorsed, or warranted by ArmaLite, Inc. ArmaLite, Inc. does not warrant or represent that this product is compatible with AR-10. "AR-10" is a federally registered trademark of ArmaLite, Inc. New Revo Brand Group, LLC, d/b/a Real Avid is not affiliated in any manner with, or otherwise endorsed by ArmaLite, Inc.



10701 FOUNTAINS DRIVE, SUITE 100  
MAPLE GROVE, MN 55369 | 800.286.0567  
REALAVID.COM

© 2026 NEW REVO BRAND GROUP, LLC.



8 13119 01639 4  
RACAT-26 PRINTED IN U.S.A.